

2019 GUIDE

HOME IoT SOLUTION
SMART HOME SYSTEM
CIP SYSTEM
MODUM SYSTEM
SMART GATE SYSTEM
GATE VIEW SYSTEM
AUDIO GATE SYSTEM
FINE VIEW

MULTI BUTTON DOOR
CAMERA
MULTI BUTTON AUDIO UNIT
DOORPHONE
INTERPHONE / INTERCOM
SMART CCTV SYSTEM
NURSE CALL SYSTEM
SMART DOOR LOCK



CONTENTS



HOME IoT SOLUTION
pg.04

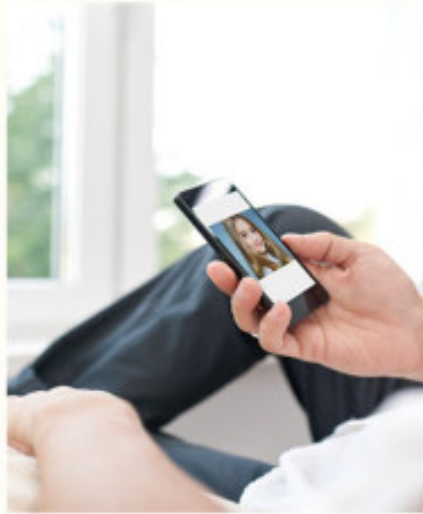

SMART HOME SYSTEM
pg.016



IP VIDEO PHONE SYSTEM
pg.022



MODUM SYSTEM
pg.024



SMART GATE SYSTEM
pg.036



GATE VIEW SYSTEM
pg.039



AUDIO GATE SYSTEM
pg.044



FINE VIEW
pg.046



MULTI BUTTON DOOR CAMERA
pg.054



MULTI BUTTON AUDIO UNIT
pg.056



DOORPHONE
pg.058



INTERPHONE / INTERCOM
pg.062



IP HOME SECU PLATFORM
pg.066



NURSE CALL SYSTEM
pg.079



SMART DOORLOCK
pg.084

HOME IoT SOLUTION	4
SMART HOME SYSTEM	16
IP VIDEO PHONE SYSTEM	22
MODUM SYSTEM	24
SMART GATE SYSTEM	36
GATE VIEW SYSTEM	39
AUDIO GATE SYSTEM	44
FINE VIEW	46
MULTI BUTTON DOOR CAMERA	54
MULTI BUTTON AUDIO UNIT	56
DOORPHONE	58
INTERPHONE/INTERCOM	62
IP HOME SECU PLATFORM	66
NURSE CALL SYSTEM	79
SMART DOORLOCK	84

HOME IoT SOLUTION

ALL DEVICES CAN BE CONNECTED VIA IP ONLY. COMMAX HOME IoT, WHICH COMBINES VERY EASY INSTALLATION AND INNOVATIVE TECHNOLOGY. THE SOLUTION FEATURES BORDERLESS EXPANDABILITY AND CONVENIENCE.



HOME IoT SOLUTION

FIELD OF HOME IoT SOLUTION APPLICATION

SINGLE HOUSE (A TYPE)

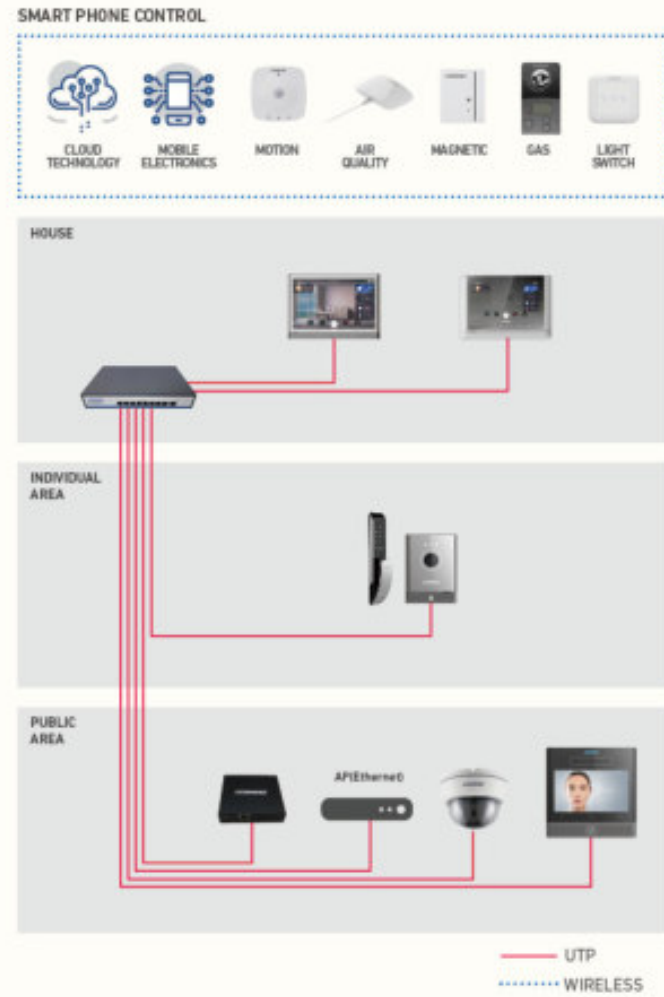

FIELD OF HOME IoT SOLUTION APPLICATION

SINGLE HOUSE (B TYPE)

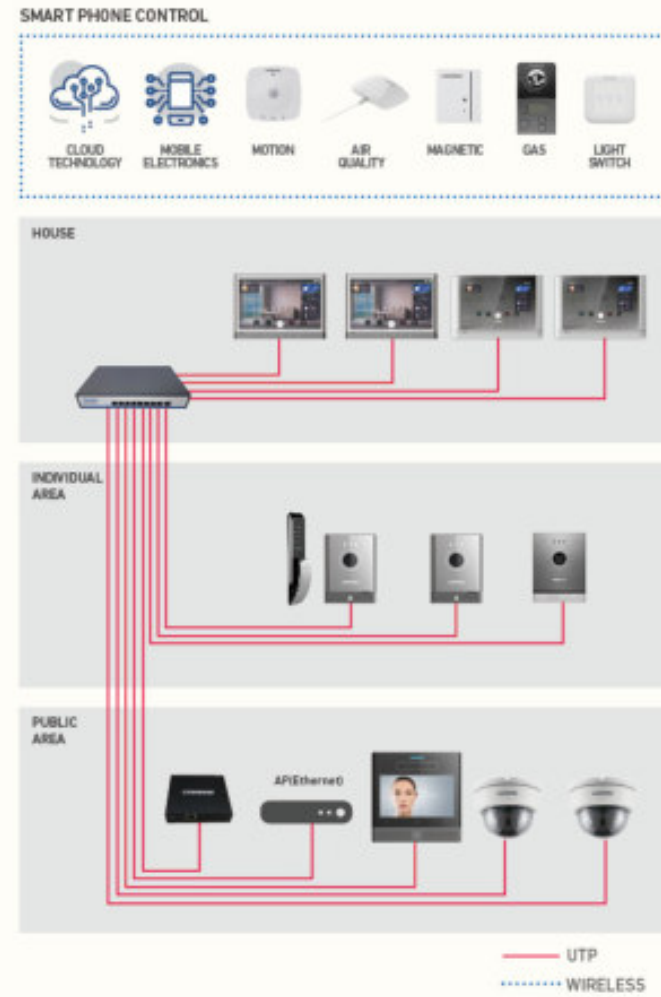

FIELD OF HOME IoT SOLUTION APPLICATION

SMALL APARTMENT BUILDING (A TYPE)

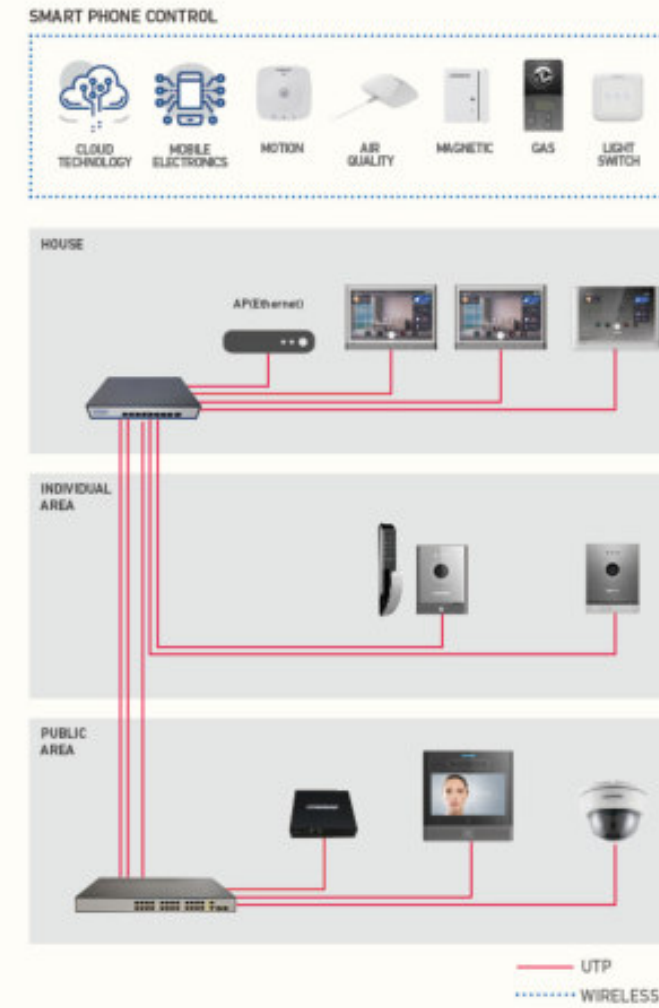

FIELD OF HOME IoT SOLUTION APPLICATION

SMALL APARTMENT BUILDING (B TYPE)

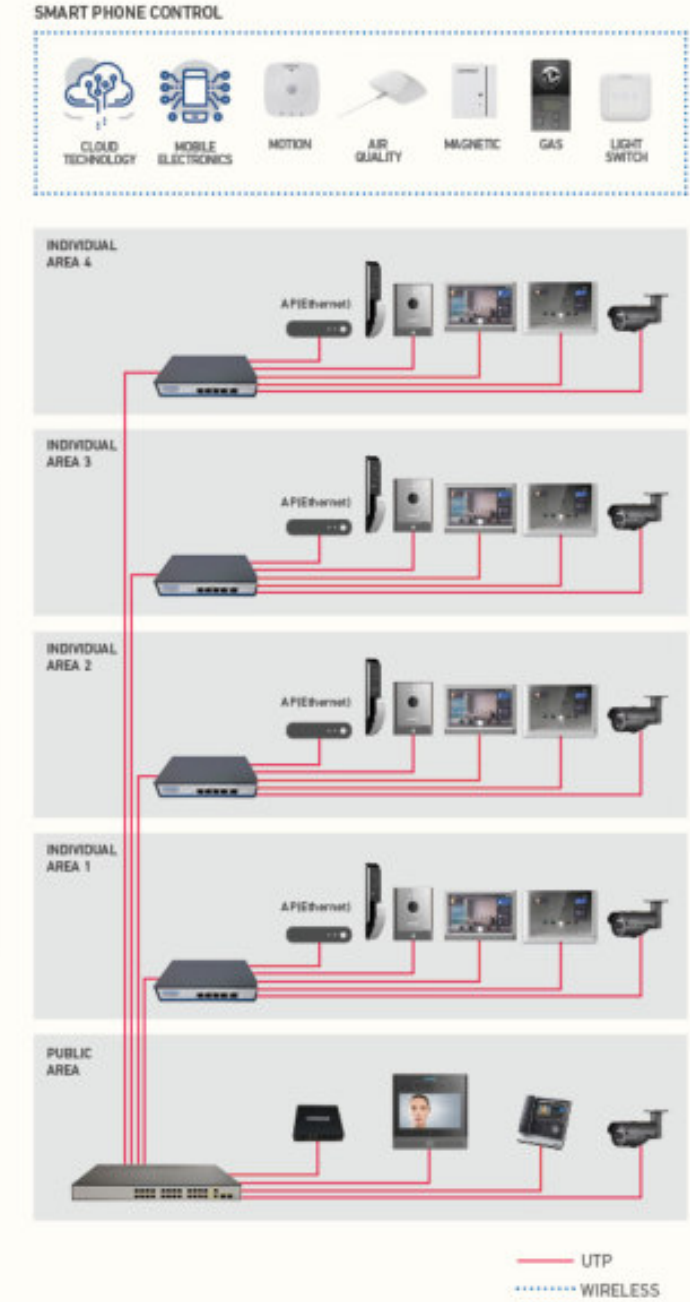

WHEN USING POE SWITCH HUB (THE ABOVE CASE)

- Device connection is based on wall pad + camera + PoE switch.
- Additional CCTV, generators, and cameras can be added as many as PoE switch HUB channels.
- Single House (B type) / Small Apartment (A type) / Small Apartment (B type) common application

- Multi-Protocol : TCP/IP, Onvif, SIP, H.264, Zigbee, Wi-Fi, BLE
- Multi-Connectivity : Wireless, Wired
- Device : Quad core CPU, FHD Resolution, Multi Touch, Built-in Memory

MONITOR CIOT-1020Y

NEW I o T



PRODUCT FUNCTION

- Support Personalized service through voice recognition and facial recognition
- Support A.I. Platform
- Playback function of pictures & videos in real time
- Automatic recording function on Door Camera by motion detection
- Synchronize all the files by Bluetooth and Wi-Fi
- Add & control of wired (RS-485) wireless device (Zigbee)

PRODUCT SPECIFICATION

Power Source	PoE S/W
Display	10.1 inch Full HD LED Display / Multi Touch
Mount Type	Flush-mounted type / Wall-mounted type
Resolution	1280 x 800
OS	Android
CPU	Quad core
VIDEO	H.264
Protocol	Wi-Fi 2.4Ghz, IEEE 802.15.4, Zigbee HA 1.2(Compatible), Bluetooth
Dimension(mm)	Flush mounted : 260(W)x182(H)x 14(32)(D) / Wall mounted : 260(W)x182(H)x 26(D)



DOOR CAMERA CIOT-D20Y

NEW I o T

PRODUCT FUNCTION

- Doorlock Release(DC Type)
- Link with smart phone(call, talk)
- SIP-based VoIP system • Touch button
- Digital Doorlock connectable
- Motion Detection
- Indoor Unit

PRODUCT SPECIFICATION

Power Source	PoE S/W
Mount Type	Wall-mounted type
Camera	2M pixel
Angle	130°
OS	Linux
VIDEO	H.264
Dimension(mm)	108(W)x146(H)x28(D)



ENTRANCE STATION CIOT-L20Y

NEW I o T

PRODUCT FUNCTION

- Voice recognition
- Fingerprint and facial recognition
- Iris recognition (option)
- E-Key function (Link with smart phone)
- Door open by RF card/password
- Application of LTE Modem (option)

PRODUCT SPECIFICATION

Power Source	DC 14V
Display	10.1 inch LED Display / Multi Touch
Mount Type	Flush-mounted type
Resolution	1280 x 800
OS	Android
CPU	Quad core
Camera	2M IP Camera (Wide Angle 142°)
Dimension(mm)	260(W)x270(H)x 26(50)(D)



A.I. TOUCHPAD ANSWER

NEW I o T

PRODUCT FUNCTION

- Voice recognition
- 10.1 inch Multi touch LED Display
- SIP, WiFi, Zigbee, Bluetooth
- Connects to IoT devices
- Connects to ACC alarm
- 1G DDR/8G eMMC Memory
- TCP/IP Communication
- Link with smart phone(Call, Talk, Control)
- Security management, disaster prevention function

PRODUCT SPECIFICATION

Power Source	DC 5V Adaptor (3.7V 4000mAh Li-Polymer)
Display	10.1 inch LED Display / Multi Touch
Mount Type	Desk top
Resolution	1280 x 800
Camera	5M pixel
OS	Android
CPU	Quad core
VIDEO	H.264
Protocol	Wi-Fi 2.4Ghz, IEEE 802.15.4, Zigbee HA 1.2(Compatible), Bluetooth, Ethernet(SIP)
Dimension(mm)	241(W)x184(H)x80(D)



AR VIEW



360° VIEW

MONITOR SMART MIRROR

NEW

I o T
-
B L E



PRODUCT FUNCTION

- Voice recognition
- Convenience : News, Calendar, TV, Public Notice
- Smart Home : Gas & Boiler and light extinguishment control
- Security : Emergency alarm, CCTV linked security and disaster prevention
- Health Care : 1:1 health check, blood glucose & body fat check etc
- Connects to IoT devices
- SIP, WiFi, Zigbee • TCP/IP Communication
- Applicable for Household, Hotel, Retail outlets
- Android based UX • Providing Full HD smart mirroring environment
- Electronic frames

PRODUCT SPECIFICATION

Display	32 inch LED Display / Multi Touch
Resolution	1920 x 1080(Full-HD)
CPU	Octa core
RAM	2GB LPDDR3
ROM	16GB eMMC FLASH
OS	Android
Wi-Fi	Wi-Fi 2.4Ghz(802.11 b/g/n)
Ethernet	TCP/IP,10/100 Mbps
Bluetooth	Version 4.0(option)
Dimension(mm)	433(W)×833(H)×50(D)

MONITOR CIOT-700M

I o T



PRODUCT FUNCTION

- Connects to IoT device
- SIP, WiFi, Zigbee
- Auto detecting slave monitor
- Connects to ACC alarm
- Ethernet 10/100 with PoE
- 1G DDR/8G eMMC Memory
- TCP/IP Communication
- Link with smart phone(Call, Talk, Control)

PRODUCT SPECIFICATION

Power Source	PoE S/W
Display	7 inch LED Display / Multi Touch
Mount Type	Wall-mounted type
CPU	Quad core
OS	Android
Protocol	Wi-Fi 2.4Ghz, IEEE 802.15.4, Zigbee HA 1.2(Compatible), Ethernet(SIP)
Dimension(mm)	244(W)×180(H)×18(D)

MONITOR CIOT-1020M

I o T



PRODUCT FUNCTION

- Vivid Metallic Design
- 10.1 inch Multi touch LED Display
- Connects to IoT device
- SIP, WiFi, Zigbee
- Auto detecting slave monitor
- Connects to ACC alarm
- Ethernet 10/100 with PoE
- 1G DDR/8G eMMC Memory
- TCP/IP Communication
- Link with smart phone(Call, Talk, Control)

PRODUCT SPECIFICATION

Power Source	PoE S/W
Mount Type	Wall-mounted type
Resolution	1280 x 800
CPU	Quad core
OS	Android
VIDEO	H.264
Protocol	Wi-Fi 2.4Ghz, IEEE 802.15.4, Zigbee HA 1.2(Compatible), Ethernet(SIP)
Dimension(mm)	308(W)×213(H)×23(D)

MONITOR CIOT-700ML

NEW



PRODUCT FUNCTION

- SIP
- Connects to ACC alarm
- Auto detecting slave monitor
- TCP/IP Communication
- Ethernet 10/100 with PoE
- 1G DDR/8G eMMC Memory
- Link with smart phone(Call, Talk, Control)

PRODUCT SPECIFICATION

Power Source	PoE S/W
Display	7 inch LED Display / Multi Touch
Mount Type	Wall-mounted type
OS	Android
CPU	Quad core
Protocol	TCP / IP
Dimension(mm)	244(W)×180(H)×18(D)



AR VIEW



360° VIEW

ENTRANCE STATION CIOT-L20M



Rainshield(option)

PRODUCT FUNCTION

- Metal is applied for front material
- 7 inch LED Display
- SIP-based VoIP system
- 2M pixel Camera
- BLE recognition
- TCP/IP Communication
- RFID card
- Motion Detection

PRODUCT SPECIFICATION

Power Source	DC 14V
Mount Type	Flush-mounted type
Operating Temp.	-40°C~+50°C
Wiring	LAN(Cat.5e)
Storage	4GB eMMC FLASH
Dimension(mm)	250(W)×255(H)×7(36)(D)
Fill up Box Size(mm)	210(W)×240(H)×81(D)

WIRELESS LIGHT SWITCH CIA-ZES0A, ZES01~ZES03



CIA-ZES0A CIA-ZES01 CIA-ZES02 CIA-ZES03

PRODUCT FUNCTION

- Bulk light control / Light control
- Zigbee communication support
- Real time status feedback
- Overload protection
- Sensitive touch control

PRODUCT SPECIFICATION

Power Source	90V~250V, 50Hz~60Hz
Output	CIA-ZES0A : 4000W/16A CIA-ZES01~ZES03 : 550W/3A(Each Button)
Protocol	Wi-Fi 2.4Ghz, IEEE 802.15.4, Zigbee HA 1.2(Compatible)
Dimension (mm)	90(W)×90(H)×11(D)

ENTRANCE STATION CIOT-L10M



Rainshield

PRODUCT FUNCTION

- 10 button Direct room call
- BLE recognition
- SIP-based VoIP system
- Registering RFID card

PRODUCT SPECIFICATION

Power Source	DC 14V
Camera	2M pixel
Angle	120d
OS	Android
VIDEO	H.264
Interface	BLE, RF, Ethernet

ENTRANCE STATION CIOT-24XM



Rainshield

PRODUCT FUNCTION

- Extension panel with name plate
- Call a household unit
- 24 button Direct room call

PRODUCT SPECIFICATION

Direct Button	24 Button (max)
---------------	-----------------

4(8) PORT POE S/W CIOT-H4L2/H8L2



PRODUCT FUNCTION

- 4(8)ch x 100Mbps port
- 4(8)ch x supporting network cable powering
- 4(8)ch x cascading LAN interfaces
- Built-in voltage-stabilized power

PRODUCT SPECIFICATION

Power Source	AC 100~240V, 50/60Hz
PoE Output	DC 52V
Speed	4/8ch x 100Mbps
Wiring	UTP(100m)
Dimension(mm)	CIOT-H4L2 : 200(W)×120(H)×40(D) CIOT-H8L2 : 270(W)×180(H)×44(D)

ENTRANCE STATION CIOT-L7FM



Rainshield

PRODUCT FUNCTION

- House call by household number
- Security office call enable
- Name searching through LED display
- SIP-based VoIP system
- BLE recognition

PRODUCT SPECIFICATION

Power Source	DC 14V
Camera	2M pixel
Angle	120°
OS	Android
VIDEO	H.264
Interface	BLE, RF, Ethernet

ENTRANCE STATION CIOT-L8TM



Rainshield

PRODUCT FUNCTION

- Hidden Pinhole Camera
- Security office call enable
- Name searching through OLED display
- SIP-based VoIP system
- BLE recognition

PRODUCT SPECIFICATION

Power Source	DC 14V
Camera	2M pixel
Angle	120°
OS	Android
VIDEO	H.264
Interface	BLE, RF, Ethernet

ENTRANCE STATION CIOT-L2TM



Rainshield

PRODUCT FUNCTION

- House call by household number
- Security office call enable
- Name searching through OLED display
- SIP-based VoIP system
- BLE recognition

PRODUCT SPECIFICATION

Power Source	DC 14V
Camera	2M pixel
Angle	120°
OS	Android
VIDEO	H.264
Interface	BLE, RF, Ethernet

DOOR CAMERA CIOT-D20M



PRODUCT FUNCTION

- DoorLock Release(DC Type)
- Link with smart phone(call, talk)
- SIP-based VoIP system
- Touch button
- Digital Doorlock connectable

PRODUCT SPECIFICATION

Power Source	PoE S/W
Mount Type	Wall-mounted type
Camera	2M pixel
Angle	130°
OS	Linux
VIDEO	H.264
Dimension(mm)	112(W)×146(H)×28(D)

DOOR CAMERA CIOT-D21M



PRODUCT FUNCTION

- Doorlock Release(DC Type)
- Tact button
- Link with smart phone(call, talk)
- SIP-based VoIP system
- Acrylic / Metallic Cover
- Digital Doorlock connectable

PRODUCT SPECIFICATION

Power Source	PoE S/W
Mount Type	Wall-mounted type
Camera	2M pixel
Angle	130°
OS	Linux
VIDEO	H.264
Dimension(mm)	112(W)×146(H)×28(D)

GUARD STATION CIOT-G700M



PRODUCT FUNCTION

- Household paging and calling function
- Visitor monitoring and calling at the public entrance
- CCTV monitoring in the public areas
- SIP-based VoIP system

PRODUCT SPECIFICATION

Power Source	DC 14V, 2.1A
Display	7 inch Touch LED Display
Mount Type	Desktop / Wall-mounted type
Camera	1M pixel, 90°
OS	Android OS
VIDEO	H.264 / MPEG4
Dimension(mm)	252(W)×247(H)×33(D)

SIP GATEWAY CGW-1KM



PRODUCT FUNCTION

- SIP Relay device
- SIP user (unit) registration function (100 units)
- Control of Emergency and Event History Management for SIP User
- Control of Access device (Lobby phone) Password and card

PRODUCT SPECIFICATION

Power Source	PoE S/W
CPU	Dual Cortex
RAM	DDR3 / 1GB
Flash	eMMC 4GB
OS	Linux
Protocol	SIP
Dimension(mm)	104(W)x94(H)x29(D)

IoT SENSOR (MAGNETIC SENSOR) CIS-MD01

IoT



PRODUCT FUNCTION

- Door open detection
- Zigbee communication support
- Low power consumption

PRODUCT SPECIFICATION

Power Source (Battery)	3V Lithium Cell (CR2032), 2EA
Sensing Mode	Magnetic
Installation	Indoor
Operating Time	2 Year(50 Times/a day)
Protocol	IEEE 802.15.4, Zigbee HA 1.2(Compatible)
Dimension(mm)	Sensor : 35(W)x55(H)x16(D) Magnetic : 11(W)x55(H)x16(D)

IoT SENSOR(PIR SENSOR) CIS-PM01

IoT



PRODUCT FUNCTION

- Motion detection
- Temperature & Humidity detection
- Low power consumption
- Zigbee communication support

PRODUCT SPECIFICATION

Power Source (Battery)	CR123A 1ea, 3V (Operating Voltage : 2.4~3V)
PIR	Distance 5m Angle 120°
Operating Temp.	-40°C ~ +125°C(+/-2°C)
Humidity	0~100%RH(+/-5%)
Operating Time	1 Year(50 Times/a day)
Protocol	IEEE 802.15.4, Zigbee HA 1.2(Compatible)
Dimension(mm)	80(W)x80(H)x60(D)

IoT SENSOR (GAS LEAK SENSOR) CIS-GD01

IoT



PRODUCT FUNCTION

- Gas leak detection
- Zigbee communication support

PRODUCT SPECIFICATION

Power Source	AC 100 ~ 240V
Installation	Kitchen
Protocol	IEEE 802.15.4, Zigbee HA 1.2(Compatible)
Dimension(mm)	70(W)x110(H)x37(D)

SMART REPEATER CIA-ZRT01

NEW

IoT



PRODUCT FUNCTION

- Able to register wallpad and each repeater device
- Extension of Zigbee wireless section and Zigbee data relay

PRODUCT SPECIFICATION

Power source	AC 220 - 250V, 60Hz
Power Consumption	Stand by : 0.38 W, Operation ; 0.83W
Operating temp.	0°C~+50°C
Protocol	IEEE 802.15.4, Zigbee HA 1.2(Compatible)

GAS VALVE BREAKER CIA-GL03

NEW

IoT



PRODUCT FUNCTION

- Gas valve blocking
- Timer function
- Including display for time confirmation
- Zigbee communication support

PRODUCT SPECIFICATION

Power Source	DC 6V (4 AA Batteries)
Sensing Temperature	More than 3 minutes at 65°C
Blocking Method	Motor Drive Method / Automatic
Blocking Time	Within 5 seconds
Action Notification	Beep Sound
Dimension(mm)	68(W)x136(H)x65(D)
Protocol	IEEE 802.15.4, Zigbee HA 1.2(Compatible)

SMART CURTAIN CIA-ZEC02

NEW

IoT



PRODUCT FUNCTION

- Curtain Open, Close & Stop Function
- Wall-mounted type
- Position control of the load check system.

PRODUCT SPECIFICATION

Power source	AC 90 - 250V, 50/60Hz
Power Consumption	Stand by : 1.7 W, Operation ; 35W
Maximum Weight (Curtain)	35Kg
Maximum Rail length	10m
Operating temp.	-10°C~50°C
Protocol	IEEE 802.15.4, Zigbee HA 1.2(Compatible)

AIR QUALITY SENSOR CIS-ZAQ01

NEW

IoT



PRODUCT FUNCTION

- LED status display
- Smart phone linked
- High sensitivity
- Zigbee communication support

PRODUCT SPECIFICATION

Power Source	DC 5V (Micro USB type)
Fine Dust	PM1.0, PM2.5, PM10
CO2	400~2,000ppm
Temperature	-10°C~+80°C (±1°C)
Humidity	0~100% (±4%)
Protocol	IEEE 802.15.4, Zigbee HA 1.2(Compatible)
Dimension (mm)	98(W)x68(H)x30(D)

SMART HOME SYSTEM

SMART HOME SYSTEM PROVIDES MORE CONVENIENT AND SAFER ENVIRONMENT WITH HOME LIFE INFORMATION.



MONITOR CAP-1400Y

NEW I o T



PRODUCT FUNCTION

- Support Personalized service through voice recognition and facial recognition
- Multi-AI function
- Playback function of pictures & videos in real time
- Automatic recording function on Door Camera by motion detection
- Synchronize all files by Bluetooth and Wi-Fi
- Add & control of wired (RS-485) wireless device (Zigbee)
- Support SD card
- Embedded 1.3M camera



PRODUCT SPECIFICATION

Power Source	DC 14V, 2A
Display	13.3 inch LED Display / Multi Touch
Mount Type	Flush mounted type
Resolution	1366 x 768
OS	Android
CPU	Quad core
VIDEO	H.264
Protocol	Wi-Fi 2.4Ghz, IEEE 802.15.4, Zigbee HA 1.2(Compatible), Bluetooth
Dimension(mm)	348.6(W)×228.5(H)×13(32)(D)

FIELD OF SMART HOME SYSTEM APPLICATION

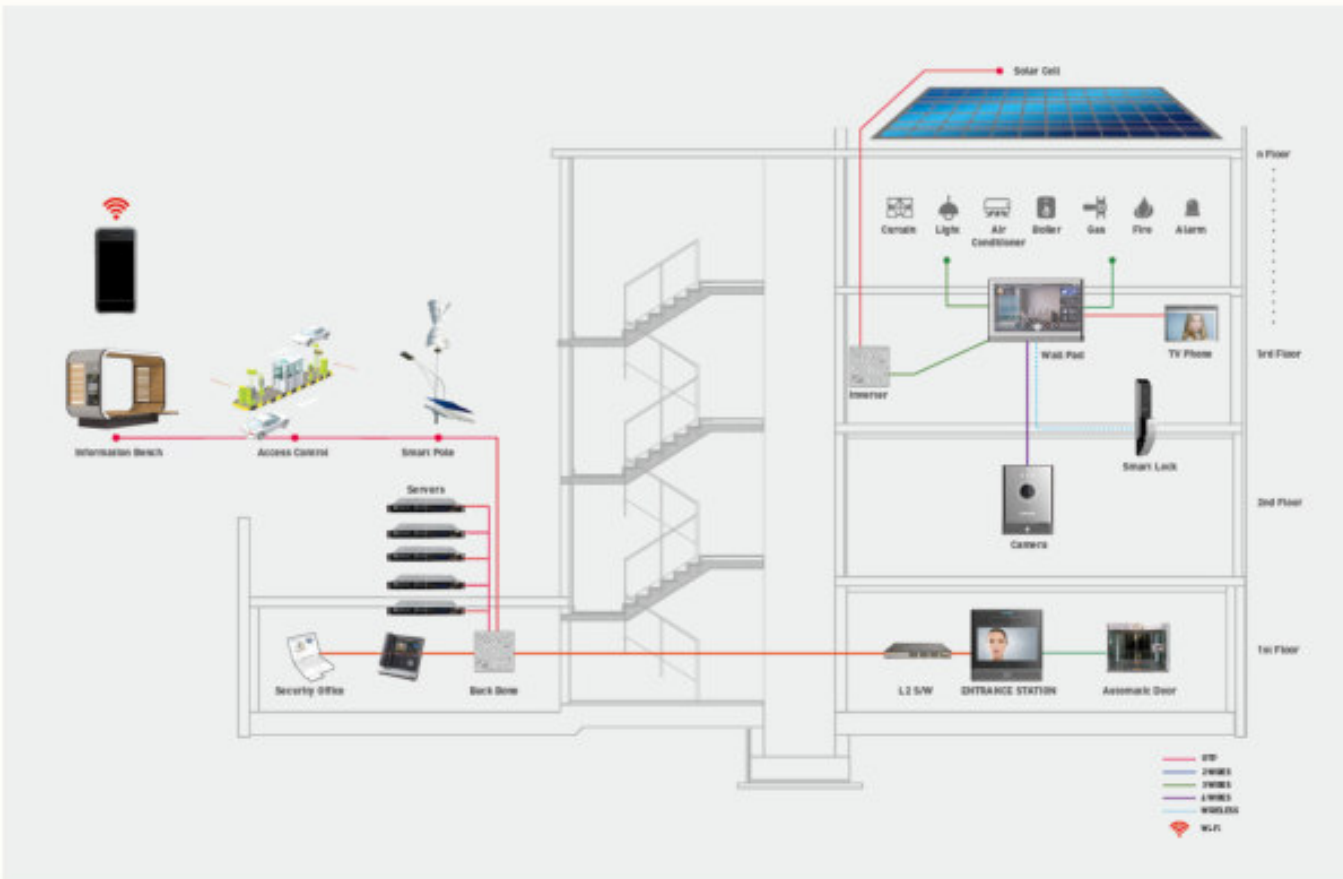

MONITOR CAP-1020Y

NEW I o T



PRODUCT FUNCTION

- Support Personalized service through voice recognition and facial recognition
- Multi-AI function
- Playback function of pictures & videos in real time
- Automatic recording function on Door Camera by motion detection
- Synchronize all files by Bluetooth and Wi-Fi
- Add & control of wired (RS-485) wireless device (Zigbee)



PRODUCT SPECIFICATION

Power Source	DC 14V, 2A
Display	10.1 inch LED Display / Multi Touch
Mount Type	Flush mounted type / Wall-mounted type
Resolution	1280 x 800
OS	Android
CPU	Quad core
VIDEO	H.264
Protocol	Wi-Fi 2.4Ghz, IEEE 802.15.4, Zigbee HA 1.2(Compatible), Bluetooth
Dimension(mm)	Flush mounted : 260(W)×182(H)× 14(32)(D) / Wall mounted : 260(W)×182(H)× 26(D)

ENTRANCE STATION
DRC-1020Y

NEW IOT



PRODUCT FUNCTION

- Voice recognition (option)
- Fingerprint and facial recognition
- Iris recognition (option)
- E-Key function (Link with smart phone)
- Door open by RF card/password
- Application of LTE Modem (option)

PRODUCT SPECIFICATION

Power Source	DC 14V
Display	10.1 inch LED Display / Multi Touch
Mount Type	Flush-mounted type
Resolution	1280 x 800
OS	Android
CPU	Quad core
Camera	2M IP Camera (Wide Angle 142°)
Dimension(mm)	260(W)×270(H)×26(50)(D)

KITCHEN TV PHONE
CKV-1400Y

NEW



PRODUCT FUNCTION

- Voice recognition
- Interlocking with existing Home network wallpad
- Interlocking with Bluetooth speaker
- Smart phone mirroring
- Digital TV and FM radio function
- Provide remote control

PRODUCT SPECIFICATION

Power Source	AC 220V
Display	13.3 inch LED Display / Multi Touch
Mount Type	Wall-mounted type
Resolution	1920 x 1080 FHD
OS	Android
CPU	Quad core
VIDEO	H.264
Protocol	Wi-Fi 2.4Ghz, Bluetooth
Dimension(mm)	332(W)×38(H)×250(D)

MONITOR
CDP-1400MB

NEW



PRODUCT FUNCTION

- 14 inch Multi Touch LED Display • Interlocking with DDL
- TCP/IP • SIP-based VoIP system • CCTV monitoring
- Convenient Function(Parking, Entrance, Package record, Weather)
- Elevator call, Boiler control • Connects to ACC alarm

PRODUCT SPECIFICATION

Power Source	DC 14V, 2A
Display	14 inch Touch LED Display / Multi Touch
Mount Type	Flush-mounted type
Wiring	UTP(CAT.5e)
OS	Android OS
Distance	Door station : 50m(0.65Ø), L2 S/W : 100m
Dimension(mm)	328(W)×230(H)×14(32)(D)

MONITOR
CSH-1020MB

NEW



PRODUCT FUNCTION

- 10.1 inch Multi Touch LED Display • Interlocking with DDL
- TCP/IP • SIP-based VoIP system • CCTV monitoring
- Convenient Function(Parking, Entrance, Package record, Weather)
- Elevator call, Boiler control • Connects to ACC alarm

PRODUCT SPECIFICATION

Power Source	DC 14V, 2A
Display	10.1 inch Touch LED Display / Multi Touch
Mount Type	Flush-mounted type
Wiring	UTP(CAT.5e)
OS	Android OS
Distance	Door station : 50m(0.65Ø), L2 S/W : 100m
Dimension(mm)	308(W)×213(H)×14(23)(D)

MONITOR
CDP-1020MB



PRODUCT FUNCTION

- 10.1 inch Multi Touch LED Display • Interlocking with DDL
- TCP/IP • SIP-based VoIP system • CCTV monitoring
- Convenient Function(Parking, Entrance, Package record, Weather)
- Elevator call, Boiler control • Connects to ACC alarm

PRODUCT SPECIFICATION

Power Source	DC 14V, 2A
Display	10.1 inch Touch LED Display / Multi Touch
Mount Type	Flush-mounted type
Wiring	UTP(CAT.5e)
OS	Android OS
Distance	Door station : 50m(0.65Ø), L2 S/W : 100m
Dimension(mm)	308(W)×213(H)×13(33)(D)

MONITOR
CDP-1020IB



PRODUCT FUNCTION

- Video call and doorlock release function enabled
- Remote control • Home devices control enabled
- Security, healthcare enable • SIP-based VoIP system
- EMS(Energy Management System)

PRODUCT SPECIFICATION

Power source	DC 14V
Display	10.1 inch Touch LED display
Mount type	Flush-mounted type
Wiring	UTP(CAT.5e)
OS	Android OS
Image sensor	1M Pixel built-in C-MOS camera
Dimension(mm)	318(W)×215(H)×18(61)(D)

ENTRANCE STATION

DRC-7MS



IoT



Rainshield

PRODUCT FUNCTION

- Metal is applied for front material
- 7 inch LED Display
- BLE recognition
- Full-HD resolution
- SIP-based VoIP system
- Page and call a household unit or a security guard station
- Embedded RFID
- 2M Pixel Camera

PRODUCT SPECIFICATION

Power source	DC 14V, 1.8A
Mount Type	Flush-mounted type
Wiring	UTP(CAT. 5e)
RFID card	13.56Mhz
Angle of view	Horiz. : 81° / Vert. : 66°
Operation temp.	-40°C~+40°C
Dimension(mm)	250(W)x255(H)x7(36)(D)

ENTRANCE STATION

DRC-703S



PRODUCT FUNCTION

- Public information display / voice announcement
- Auto panel-lighting control by proximity sensor
- household unit call
- Embedded RFID
- SIP-based VoIP system
- Security office call

PRODUCT SPECIFICATION

Power source	DC 14V, 2A
Mount type	Flush-mounted type
Operation Temp.	-40°C~40°C
Wiring / OS	LAN(CAT. 5e) / Android OS
Data transmission	TCP/IP, RS 485
Memory / Storage	DDR3 1GB / 4GB eMMC
Dimension(mm)	244(W)x270(H)x19(47)(D)

KITCHEN TV PHONE

CKV-1020FS



PRODUCT FUNCTION

- Digital TV/High sensitivity digital FM
- Tempered Glass with touch panel
- User-friendly GUI
- Telephone call receiving enabled, Video playback
- Built-in MP3

PRODUCT SPECIFICATION

Power source	AC 100~240V, 50/60Hz
Display	10.1 inch Touch LED display
Mount type	Wall-mounted type
Package	Main console, Remote control
Signal	ATSC/QAM (Unscrambled)
H/N, H/A	RS-485
Dimension(mm)	322(W)x262(H)x34(D)

SERVER

CHS-10LS/DS/BS



PRODUCT FUNCTION

- Operation function of resident administration page
- Interlocking with smart metering, parking, courier, DVR and elevator servers
- Residential Units, Complexes and Product data storage

PRODUCT SPECIFICATION

CPU	Intel Xeon Harpertown E5405 (Quad Core/2.0G, 12M, 1333MHz)
RAM	4G DDR FB-DIMM(2Gx2ea) 8 slots(Max.16G)
OS	Embedded Linux
ODD	1TB S-ATA3, 7200rpm, 32MB
Dimension(mm)	430(W)x44(H)x650(D)
Data transmission	TCP/IP
Dimension(mm)	252(W)x247(H)x40(D)

LAYER 2 SWITCH

CSS-24H2/DY



PRODUCT FUNCTION

- Twenty-four 10/100M Ethernet electrical Port
- Two GE RJ45 Ports
- Two GE SFP Port
- AC Power Supply
- Packet Forwarding rate : 9.6 Mpps
- Switching Capacity : 12.8 Gbps

PRODUCT SPECIFICATION

Downlink port	Twenty-four 10/100M electrical ports
Uplink port	2GE electrical ports 2GE SFP optical ports
MAC address table	8K MAC
Dimensions(mm)	442(W)x44(H)x220(D)
Input voltage	AC100-240V, 50/60Hz
Power consumption	20W
Operating temp.	0°C~45°C

LAYER 3 SWITCH

CSS-24H3/DY



PRODUCT FUNCTION

- Twenty 100/1000Base-X ports and four GE combo ports
- Subcards supported : 4x1000Base-X SFP subcard, 2x10GE SFP+ subcard and 4x10GE SFP+ subcard

PRODUCT SPECIFICATION

RAM	63W
Fixed port	20x 100/1000Base-X ports and 4 Combo
Forwarding performance	96Mpps
Switching capacity	128Gbps
MAC address table	32K
Input voltage	AC 100-240V, 50/60Hz DC -48V~60V
Dimensions(mm)	442(W)x44(H)x420(D)

GUARD STATION

CDS-70M



PRODUCT FUNCTION

- Household paging and calling function
- Visitor monitoring and calling at the public entrance
- CCTV monitoring in public areas
- SIP-based VoIP system

PRODUCT SPECIFICATION

Power	DC14V/1.8A
Display	7 inch wide color LCD
Mount type	Desktop / Wall-mounted type
Operating temp.	0°C~40°C
Wiring	LAN(CAT.5e)
Data transmission	TCP/IP
Dimension(mm)	252(W)x247(H)x40(D)

SENSOR

CPA-4012



PRODUCT FUNCTION

- Infrared ray energy sensor
- Normal operation enabled after 30 seconds from powered on
- Indoor use
- Wall mounted type

PRODUCT SPECIFICATION

Power / Consumption	DC 8~18V / Max 20mA
Alarm output	1B(COM, NC OR NO)
Detection speed / range	0.3~1.5m/s / 0.5~12m
Installation	2.5m
Operating temp.	-20°C~+60°C
Dimension (mm)	63(W)x110(H)x47(D)
Weight(g)	68

SENSOR

CPA-0212



PRODUCT FUNCTION

- Mirror-typed infrared sensor
- Detects infrared rays from 7um~15umz
- Indoor use
- Ceiling mounted type

PRODUCT SPECIFICATION

Power / Consumption	DC 9~18V / Max 10mA
Alarm output	1B(COM, NC OR NO)
Detection speed / range	0.2~1.5m/s / 12m (Mirror type)
Alarm time	2 Sec
Installation	1.8~3m
Operating temp.	-20°C~+60°C
LED	Warning : Intrusion : Red

SENSOR

MS-10



PRODUCT FUNCTION

- Magnetic typed sensor
- Indoor use
- Door/Window frame wall-mounted type

PRODUCT SPECIFICATION

Power input	DC 9~13V
Consumtion	Max 10mA
Effective range	27mm
Detection type	N.C
Reed S/W	Flex/MDSR Type
Operating temp.	-20°C~+70°C
Dimension (mm)	12(W)x55(H)x13(D)

SENSOR

CPB-30S



PRODUCT FUNCTION

- Minimum reflection
- Wide range of adjustment
- IP44 compliance
- Both indoor and outdoor installation enabled

PRODUCT SPECIFICATION

Power input / Consumption	DC 11~25VDC / Max 57mA
Detection method	Near-infrared / Beam block
Detection range	Outdoor : 30m / Indoor : 60m
Detection type	Pulse beam by LED Double variation method
LED	Warning : Green / Intrusion : Red
Operating temp.	-20°C~+60°C
Dimension (mm)	63(W)x163(H)x75(D)

SENSOR

CPB-10S



PRODUCT FUNCTION

- Minimum reflection
- Wide range of adjustment
- IP44 compliance
- Both indoor and outdoor installation enabled

PRODUCT SPECIFICATION

Power input / Consumption	DC 11~25VDC / Max 57mA
Detection method	Near-infrared / Beam block
Detection range	Outdoor : 10m / Indoor : 20m
Detection type	Pulse beam by LED Double variation method
LED	Warning : Green / Intrusion : Red
Operating temp.	-20°C~+60°C
Dimension (mm)	63(W)x163(H)x75(D)

IP VIDEO PHONE SYSTEM

IP VIDEO PHONE SYSTEM PROVIDES OPTIMIZED SECURITY FUNCTIONS AND COMPLEX MONITORING WITHOUT TIME AND PLACE RESTRICTION, ENABLES A COST-EFFECTIVE IMPLEMENTATION OF HOME NETWORK.



FIELD OF IP VIDEO PHONE SYSTEM APPLICATION

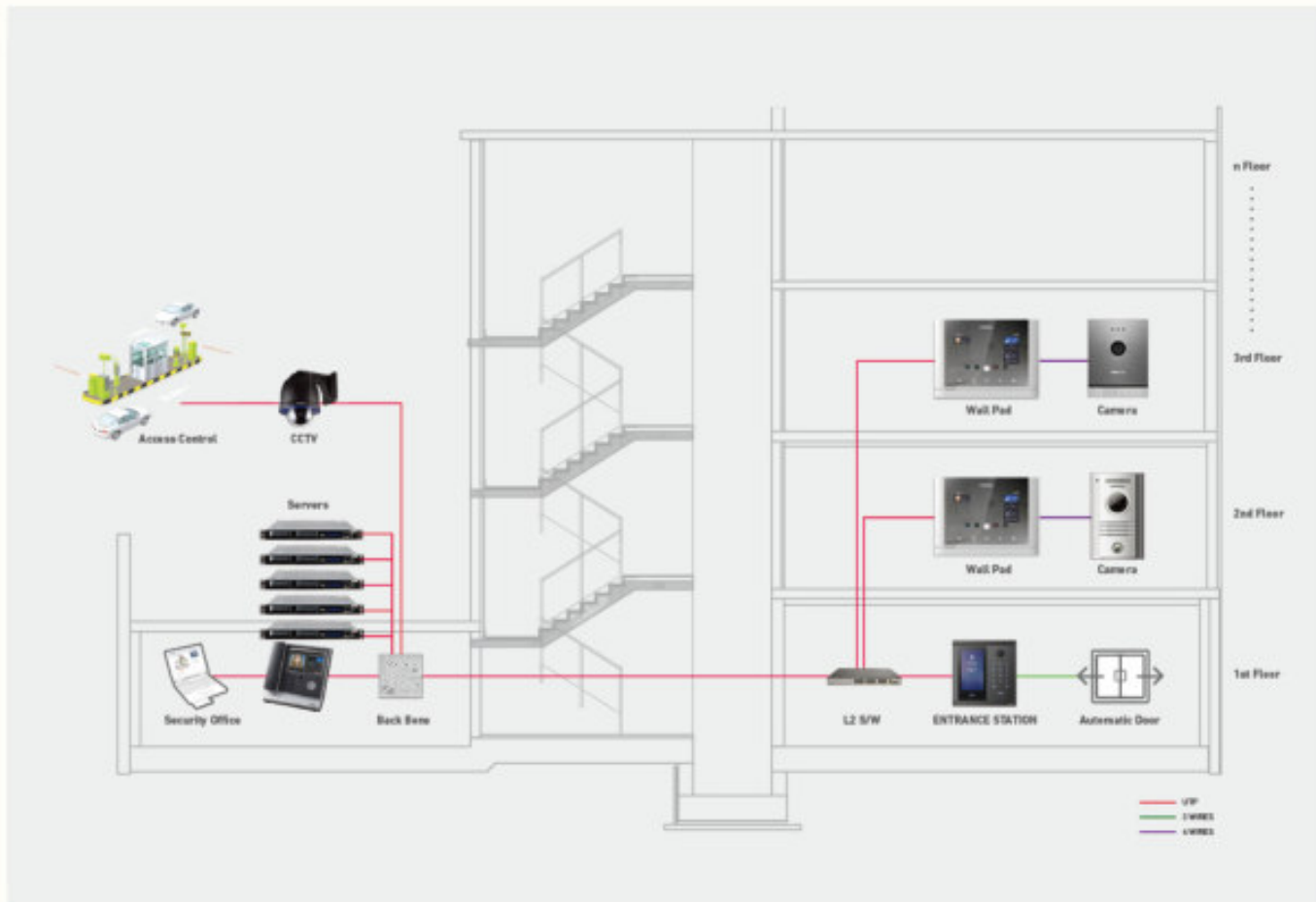

MONITOR CIP-700ML



PRODUCT FUNCTION

- SIP-based VoIP system

ECO : EMS(Energy Management System)/standby power breaker/light-out/solar-power link/IHD/electronic meters link

Security : monitoring CCTV in public area/integrated doorlock

Convenience function : single-pass system/visitor identification/ voice mail/ alarm/scheduling/elevator call/apartment complex information search/video and voice call between households/ integrated unmanned delivery

PRODUCT SPECIFICATION

Power source	AC 100~240V, 50/60Hz
Display	7 inch Touch LED display
Mount type	Wall-mounted type
Operating temp.	0°C~40°C
Wiring	LAN(CAT.5e)
Data transmission	TCP/IP, RS 485
OS	Android OS
Memory	DDR3 1GB
Storage	4GB eMMC
Touch panel	Resistance Touch Panel
Resolution	800×480 Digital LCD
LAN	Ethernet 100
Dimension(mm)	244(W)×180(H)×18(D)

CONNECTABLE PRODUCTS



MODUM SYSTEM (HYBRID SYSTEM)

MODUM IS A HYBRID SYSTEM WITH INTERGRATED IOT, DOOR ENTRY SYSTEM, CCTV AND ACCESS CONTROL.



FIELD OF MODUM SYSTEM APPLICATION

APARTMENT COMPLEX

"MODUM HOME IoT MONITOR" AND "MODUM MONITOR" CAN BE USED TOGETHER.

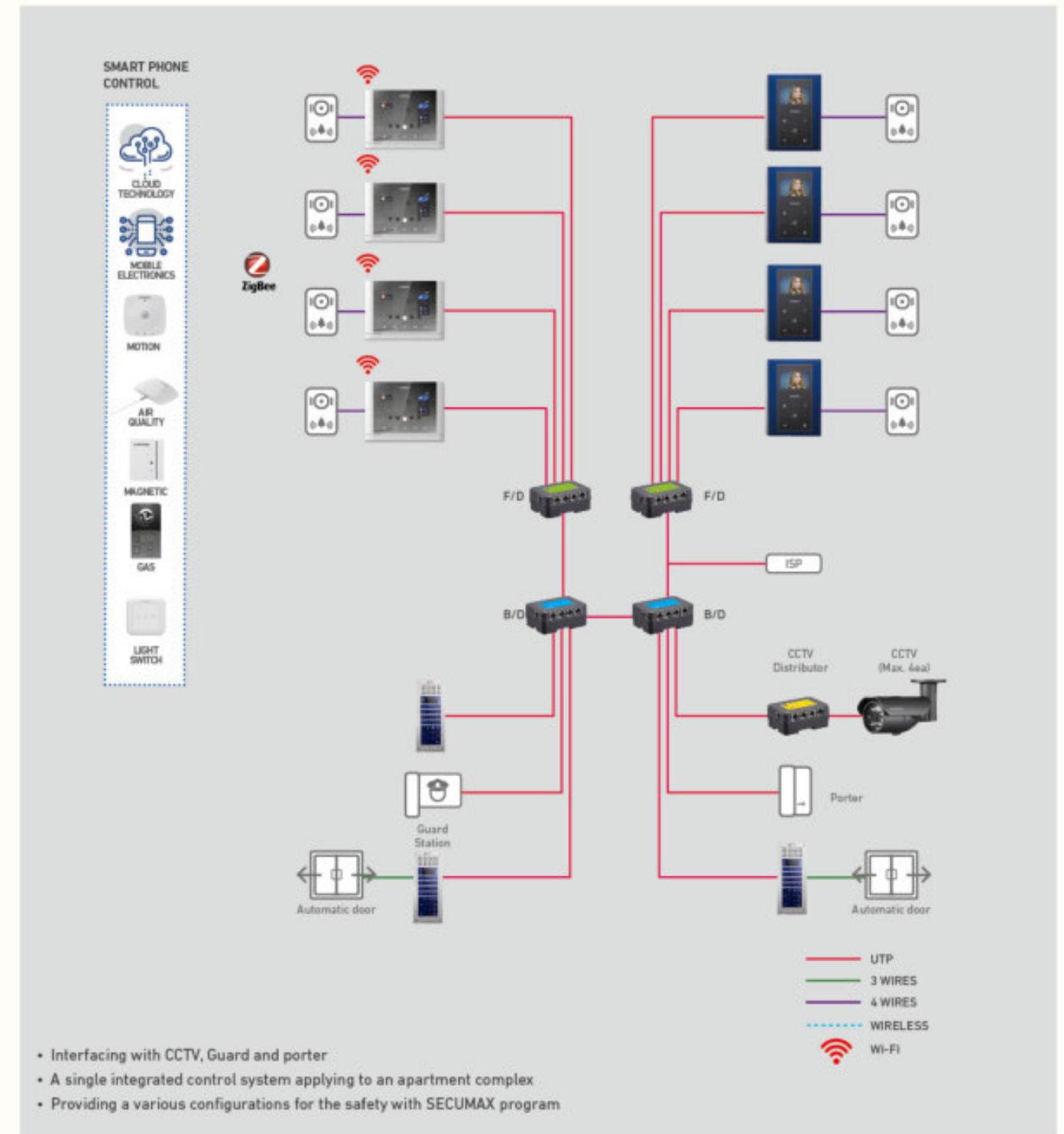

MODUM SYSTEM (HYBRID SYSTEM)

FIELD OF MODUM SYSTEM APPLICATION

SMALL APARTMENT BUILDING [UTP]

SMART PHONE CONTROL

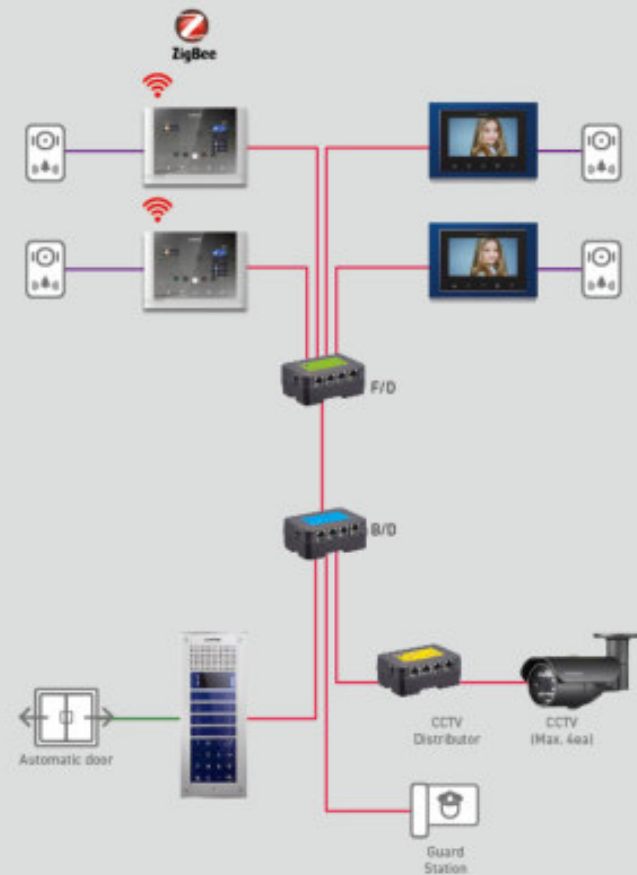

- The best unmanned security system for a small apartment building.
- Supporting up to 316 households and simple door opening with various access ways.
- - Pin number, RFID card, Direct button call, Name search, Guard call, Porter call

MODUM SYSTEM (HYBRID SYSTEM)

FIELD OF MODUM SYSTEM APPLICATION

SMALL APARTMENT BUILDING (UTP)

- AUDIO PHONE AND MONITOR CAN BE USED TOGETHER.

SMART PHONE CONTROL

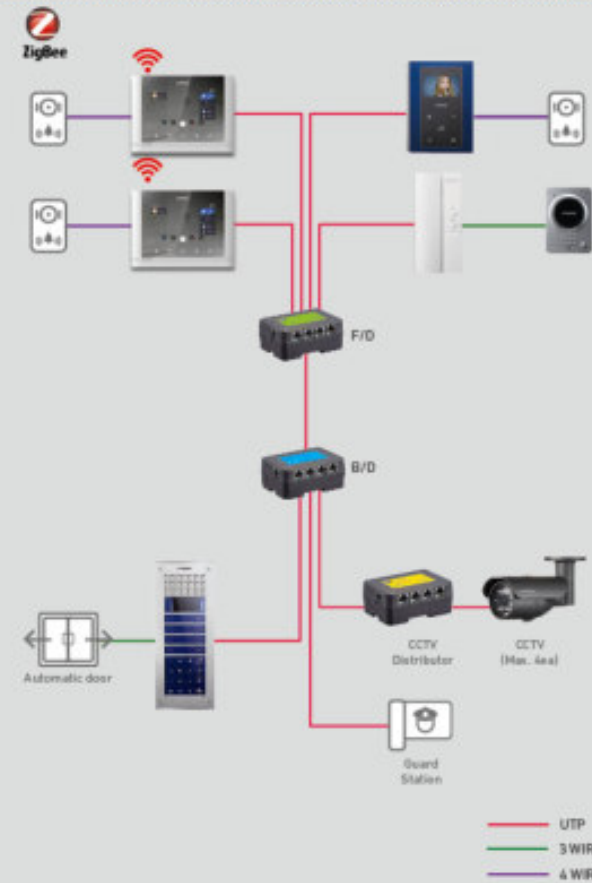

- The best unmanned security system for a small apartment building.
- Supporting up to 316 households and simple door opening with various access ways.
- - Pin number, RFID card, Direct button call, Name search, Guard call, Porter call

FIELD OF MODUM SYSTEM APPLICATION

SMALL APARTMENT BUILDING [UTP]

- UP TO 8 UNITS CAN BE INSTALLED PER 1 HOUSE THROUGH THE MODUM HOUSE DISTRIBUTOR.

SMART PHONE CONTROL

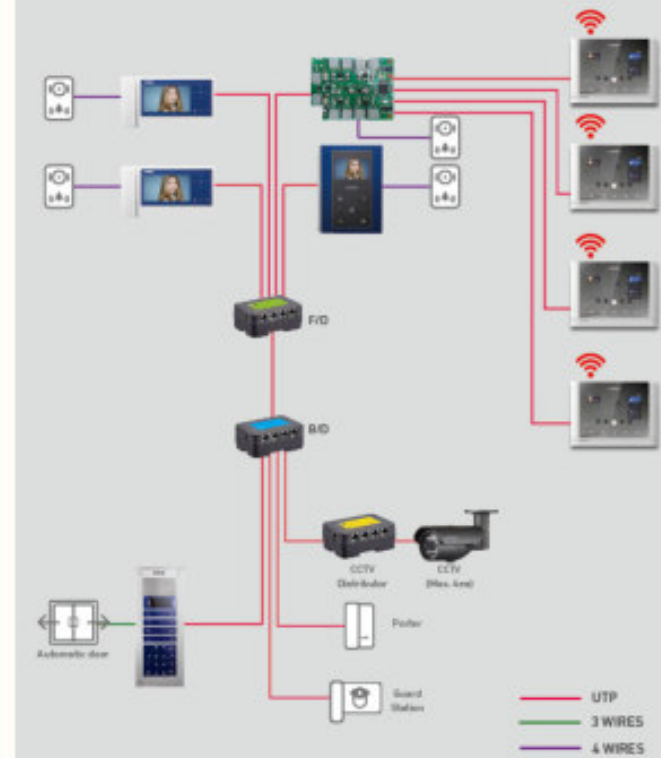

- The best unmanned security system for a small apartment building.
- Supporting up to 316 households and simple door opening with various access ways.
- - Pin number, RFID card, Direct button call, Name search, Guard call, Porter call

MODUM SYSTEM (HYBRID SYSTEM)

FIELD OF MODUM SYSTEM APPLICATION

SINGLE HOUSE (A TYPE)

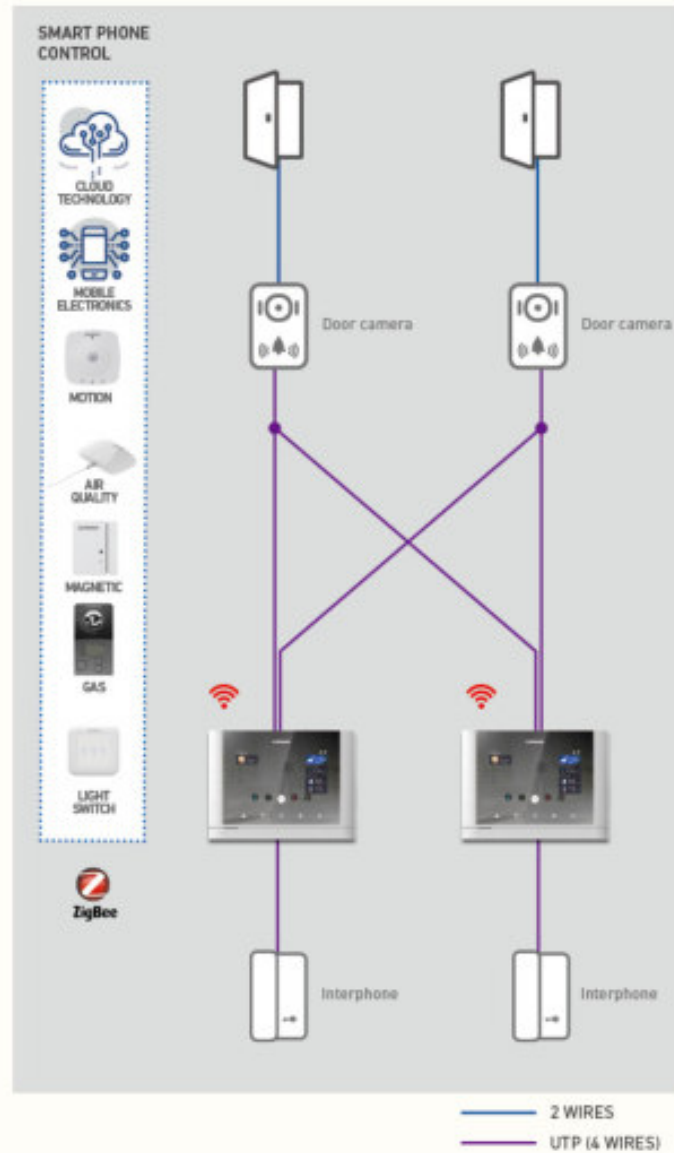

SINGLE HOUSE (A TYPE)

- Easy installation for a 2 doors house(Front&garage door)
- Support 2 monitors, 2 cameras and 2 interphones

FIELD OF MODUM SYSTEM APPLICATION

SINGLE HOUSE (B TYPE)

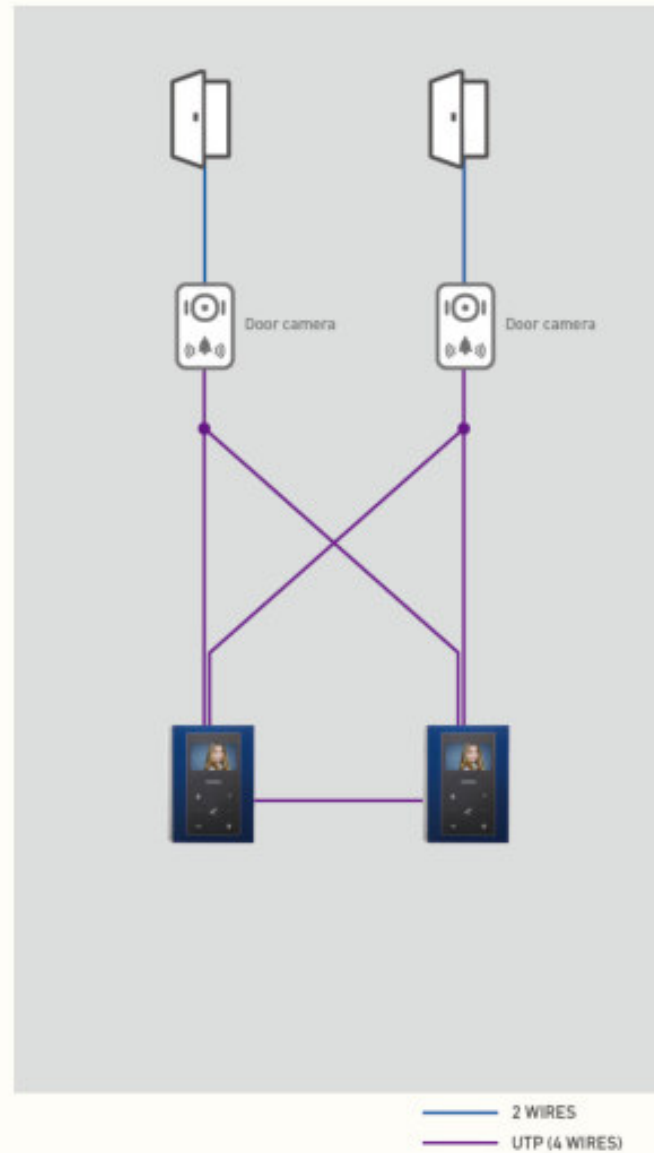

SINGLE HOUSE (B TYPE)

- Easy installation for a 2 doors house(Front&garage door)
- Support 2 monitors, 2 cameras
- Intercommunication between 2 monitors

MONITOR CMV-70MX

IoT



PRODUCT FUNCTION

- Connectable with smart phone and security IoT sensor
- 7 inch Multi touch LED Display
- CCTV Monitoring • Guard Call & Talk • Porter Call & Talk
- Compatible with Single House and Apartment Complex

PRODUCT SPECIFICATION

Power source	AC 100-240V, 50/60Hz
Display	7 inch LED Display / Multi Touch
Mount Type	Wall-mounted type
Wiring & Distance	Door camera : Cat.5e (28m) Floor Distributor : UTP / (28m) / 2 wires
IoT Sensor	Zigbee protocol
Protocol	Wi-Fi 2.4Ghz, IEEE 802.15.4, Zigbee HA 1.2(Compatible)
Dimension(mm)	244(W)x180(H)x18(D)

MONITOR CMV-77K/77KD

NEW



PRODUCT FUNCTION

- Visitor identification and call via smart phone(CGW-M2I)
- CCTV Monitoring • Guard Call & Talk • Porter Call & Talk
- Video talk and doorlock release enable
- Compatible with Single House and Apartment Complex

PRODUCT SPECIFICATION

Power source	CMV-77K : AC 100-240V, 50/60Hz CMV-77KD : DC 24V(from CMD-404FUD)
Display	7 inch wide LED display
Mount type	Wall-mounted type
Operating temp.	0°C--+40°C
Distance	28m(0.5mm) / 50m(0.65mm) / 70m(0.8mm)
Dimension(mm)	311(W)x168(H)x32(D)

MONITOR CMV-70S/70SD

NEW



PRODUCT FUNCTION

- Visitor identification and call via smart phone(CGW-M2I)
- CCTV Monitoring • Guard Call & Talk • Porter Call & Talk
- Video talk and doorlock release enable
- Compatible with Single House and Apartment Complex

PRODUCT SPECIFICATION

Power source	CMV-70S : AC 100-240V, 50/60Hz CMV-70SD : DC 24V(from CMD-404FUD)
Display	7 inch wide LED display
Mount type	Wall-mounted type
Operating temp.	0°C--+40°C
Distance	28m(0.5mm) / 50m(0.65mm) / 70m(0.8mm)
Dimension(mm)	244(W)x180(H)x32(D)

MONITOR CMV-70M/70MD

NEW



PRODUCT FUNCTION

- Visitor identification and call via smart phone(CGW-M2I)
- CCTV Monitoring • Guard Call & Talk • Porter Call & Talk
- Video talk and doorlock release enable
- Compatible with Single House and Apartment Complex

PRODUCT SPECIFICATION

Power source	CMV-70M : AC 100-240V, 50/60Hz CMV-70MD : DC 24V(from CMD-404FUD)
Display	7 inch wide LED display
Mount type	Wall-mounted type
Operating temp.	0°C--+40°C
Distance	28m(0.5mm) / 50m(0.65mm) / 70m(0.8mm)
Dimension(mm)	244(W)x180(H)x18(D)

MONITOR CMV-43S/43SD

NEW



PRODUCT FUNCTION

- Visitor identification and call via smart phone(CGW-M2)
- CCTV Monitoring • Guard Call & Talk
- Porter Call & Talk • Compatible with Single House and Apartment Complex

PRODUCT SPECIFICATION

	CMV-43S:AC100-240V,50/60Hz
Power source	CMV-43SD: DC 24V(from CMD-404FUD)
Mount type	Wall-mounted type
Operating temp.	0°C~+40°C
Distance	28m(0.5mm) / 50m(0.65mm) / 70m(0.8mm)
Dimension (mm)	180(W)×244(H)×32(D)

MONITOR CMV-43A/43AD

NEW



PRODUCT FUNCTION

- Visitor identification and call via smart phone(CGW-M2)
- CCTV Monitoring • Guard Call & Talk
- Porter Call & Talk • Compatible with Single House and Apartment Complex

PRODUCT SPECIFICATION

	CMV-43A:AC100-240V,50/60Hz
Power source	CMV-43AD: DC 24V(from CMD-404FUD)
Mount type	Wall-mounted type
Operating temp.	0°C~+40°C
Distance	28m(0.5mm) / 50m(0.65mm) / 70m(0.8mm)
Dimension (mm)	180(W)×180(H)×28(39)(D)

AUDIO PHONE CMA-3L/3LD

NEW



PRODUCT FUNCTION

- Guard Call & Talk
- Doorlock release enable
- Compatible with Single House and Apartment Complex

PRODUCT SPECIFICATION

	AC 220V, 50/60Hz
Power source	DC 24V(from CMD-404FUD)
Mount type	Wall-mounted type
Operating temp.	0°C~+40°C
Distance	28m(0.5mm) / 50m(0.65mm) / 70m(0.8mm)
Dimension (mm)	98(W)×215(H)×43(D)

ENTRANCE STATION CMP-2BCT/4BCT



PRODUCT FUNCTION

- Access Control(PIN number/RFID card)
- Name searching through 2.4" OLED display
- Page and call a household unit or a security guard station • C-MOS(Pin-hole type)

PRODUCT SPECIFICATION

Power source	DC 12V, 1A
Mount type	Flush-mounted type
Wiring	Building Distributor : UTP
RFID card	13.56Mhz(optional)
Angle of view	Horiz.: 47°, Vert.: 35°
Operating temp.	-20°C~+40°C
Dimension (mm)	130(W)×315(H)×12(38)(D)

ENTRANCE STATION CMP-2BC/4BC



PRODUCT FUNCTION

- 16 / 32 Direct buttons call
- Page and call a household unit

PRODUCT SPECIFICATION

Power source	DC 12V, 1A
Mount type	Flush-mounted type
Wiring	Building Distributor : UTP
Image sensor	C-MOS(Pin-hole type)
Angle of view	Horiz.: 47°, Vert.: 35°
Operating temp.	-20°C~+40°C
Dimension (mm)	130(W)×315(H)×12(38)(D)

ENTRANCE STATION CMP-CTS/RF1



PRODUCT FUNCTION

- Access Control(PIN number/RFID card)
- Name searching through 2.4" OLED display
- Page and call a household unit or a security guard station • C-MOS(Pin-hole type)

PRODUCT SPECIFICATION

Power source	DC 12V, 1A
Mount type	Flush-mounted type
Wiring	Building Distributor : UTP
RFID card	13.56Mhz(optional)
Angle of view	Horiz.: 47°, Vert.: 35°
Operating temp.	-20°C~+40°C
Dimension (mm)	130(W)×249(H)×12(38)(D)

ENTRANCE STATION DRC-7MBL/RF1



PRODUCT FUNCTION

- Metal is applied for front material
- BLE recognition
- 3.5 inch LED Display
- Page and call a household unit or a security guard station
- Embedded RFID

PRODUCT SPECIFICATION

Power source	DC 12V, 1A
Mount Type	Flush-mounted type
Operating temp.	-20°C~+50°C
Wiring	UTP(CAT. 5e)
Distance	Max.300m
RFID card	13.56Mhz(optional)
Angle of view	Horiz.: 81°, Vert.: 66°
Dimension(mm)	250(W)×255(H)×7(36)(D)



Rainshield(option)



360° VIEW

ENTRANCE STATION CMP-2BCS/4BCS



PRODUCT FUNCTION

- 8 / 16 Direct buttons call
- Page and call a household unit

PRODUCT SPECIFICATION

Power source	DC 12V, 1A
Mount type	Flush-mounted type
Wiring	Building Distributor : UTP
Image sensor	C-MOS(Pin-hole type)
Angle of view	Horiz.: 47°, Vert.: 35°
Operating temp.	-20°C~+50°C
Dimension (mm)	130(W)×249(H)×12(38)(D)

ENTRANCE STATION CMP-2BAT/4BAT



PRODUCT FUNCTION

- Access Control(PIN number/RFID card)
- Name searching through 2.4" OLED display
- Page and call a household unit or a security guard station

PRODUCT SPECIFICATION

Power source	DC 12V, 1A
Mount type	Flush-mounted type
Wiring	Building Distributor : UTP
RFID card	13.56Mhz(optional)
Display	2.4" OLED display
Operating temp.	-20°C~+40°C
Dimension (mm)	130(W)×315(H)×12(38)(D)

ENTRANCE STATION CMP-2BA



PRODUCT FUNCTION

- 16 button Direct room call
- Page and call a household unit

PRODUCT SPECIFICATION

Power source	DC 12V, 1A
Mount type	Flush-mounted type
Wiring	Building Distributor : UTP
Operating temp.	-20°C~+50°C
Dimension (mm)	130(W)×315(H)×12(38)(D)

EXTENSION NAME PANEL
DRC-NP



PRODUCT FUNCTION

- Wide name plate
- Instruction note
- Guide manual

PRODUCT SPECIFICATION

Mount type	Flush-mounted type
Dimension (mm)	130(W)×315(H)×12(38)(D)

EXTENSION PANEL
CMP-2BX



PRODUCT FUNCTION

- 24 Direct buttons call

PRODUCT SPECIFICATION

Power source	From Entrance station panel
Mount type	Flush-mounted type
Operating temp.	-20°C~+40°C
Dimension (mm)	130(W)×315(H)×12(38)(D)

EXTENSION PANEL
CMP-4BX



PRODUCT FUNCTION

- 48 Direct buttons call

PRODUCT SPECIFICATION

Power source	From Entrance station panel
Mount type	Flush-mounted type
Operating temp.	-20°C~+40°C
Dimension (mm)	130(W)×315(H)×12(38)(D)

ENTRANCE STATION
DRC-900LC/RF1



PRODUCT FUNCTION

- Vandal-proof Aluminium Die-casting Case
- IR sensor Type Anti-freezing Buttons
- Security guard station call enabled
- Page and call a household unit
- Pin-hole Camera

PRODUCT SPECIFICATION

Power source	DC 12V, 1A
Mount Type	Wall-mounted type
Operating temp.	-20°C~+60°C
Wiring	UTP(CAT. 5e)
RFID card	13.56Mhz(optional)
Dimension(mm)	136(W)×260(H)×36(D)
Rain-shield(mm)	140(W)×260(H)×65(D)

ENTRANCE STATION
DRC-GUM



PRODUCT FUNCTION

- Access Control(PIN number/RFID card)
- Page and call a household unit or a security guard station
- Name searching through 2.4" OLED display
- C-MOS

PRODUCT SPECIFICATION

Power source	DC 12V, 1A
Mount type	Flush-mounted type
Wiring	Building Distributor : UTP
RFID card	13.56Mhz(optional)
Angle of view	Horiz.: 47°, Vert.: 35°
Operating temp.	-20°C~+40°C
Dimension (mm)	130(W)×315(H)×12(38)(D)

EXTENSION PANEL
CMP-2BXS



PRODUCT FUNCTION

- 16 button Direct room call Extension panel

PRODUCT SPECIFICATION

Power source	From Entrance station panel
Mount type	Flush-mounted type
Operating temp.	-20°C~+40°C
Dimension (mm)	130(W)×249(H)×12(38)(D)

EXTENSION PANEL
CMP-4BXS



PRODUCT FUNCTION

- 32 button Direct room call Extension panel

PRODUCT SPECIFICATION

Power source	From Entrance station panel
Mount type	Flush-mounted type
Operating temp.	-20°C~+40°C
Dimension (mm)	130(W)×249(H)×12(38)(D)

ENTRANCE STATION
DRC-703LC/RF1



PRODUCT FUNCTION

- Page and call a household unit or a security guard station
- Various verification methods (PIN number and RFID card)
- Expandable up to 99 units of DRC-703 LC/RF1

PRODUCT SPECIFICATION

Power source	DC 12V, 1A
Mount type	Flush-mounted type
Wiring	Building Distributor : UTP
RFID card	13.56Mhz(optional)
Angle of view	Horiz.: 68°, Vert.: 55°
Operating temp.	-40°C~+40°C
Dimension (mm)	244(W)×270(H)×17(43)(D)

EXTENSION PANEL
DRC-12UX



PRODUCT FUNCTION

- 12 Direct buttons call Extension panel with name plate
- Expandable up to 5 units(60 buttons)

PRODUCT SPECIFICATION

Power source	From Entrance station panel
Mount type	Flush-mounted type
Operating temp.	-40°C~+40°C
Dimension (mm)	130(W)×315(H)×12(38)(D)

FLOOR DISTRIBUTOR (ALL UTP)
CMD-404FU



PRODUCT FUNCTION

- All UTP Wiring Floor distributor
- Connectable with Video Phone up to 4ea

PRODUCT SPECIFICATION

Power source	DC 24V, 1A(From Building distributor)
Wiring	-Household unit-to-Floor distributor : UTP -Building distributor-to-Floor distributor : UTP -Floor distributor-to-Floor distributor : UTP
Mount type	Din-Rail Mounted type
Dimension (mm)	106(W)×76(H)×44(D)

BUILDING DISTRIBUTOR(ALL UTP)
CMD-101BU



PRODUCT FUNCTION

- All UTP Wiring Building distributor
- Connectable with Lobby, Guard, Porter, CCTV distributor, Floor distributor

PRODUCT SPECIFICATION

Power source	DC 24V, 1A
Wiring	-Household distributor-to-Floor distributor : UTP -Household distributor-to-Household unit : UTP -Household distributor-to-Camera : UTP
Mount type	Din-Rail Mounted type
Dimension (mm)	106(W)×76(H)×44(D)

CCTV DISTRIBUTOR (ALL UTP)
CMD-104VU



PRODUCT FUNCTION

- Connectable with CCTV Camera up to 4ea
- Power supply to CCTV Camera

PRODUCT SPECIFICATION

Power source	DC 14V, 4A PoD(Power on Distributor)
Wiring	-CCTV distributor-to-Building distributor : UTP -CCTV distributor-to-CCTV cameras : UTP
Mount type	Din-Rail Mounted type
Dimension(mm)	106(W)×76(H)×44(D)

CCTV CAMERA(BULLET)
CAU-D047TP



PRODUCT FUNCTION

- PoD(Power on Distributor)
- 700TV Line high resolution
- 2D/3D DNR / • IP 66
- Over exposure prevent function

PRODUCT SPECIFICATION

Power	Power from CCTV distributor
Image sensor	1/3" SONY 960H SUPER HAD II CCD
Min. Illumination	0.1Lux at F1.2
Lens	3.6mm fixed focus lens
Wiring	CCTV distributor-to-CCTV cameras : UTP

CCTV CAMERA(DOME)
CAD-I4V7TP



PRODUCT FUNCTION

- All UTP Wiring Building distributor
- Connectable with Lobby, Guard, Porter, CCTV distributor • 2.8mm-12mm varifocal lens
- 2D/3D DNR • 700TV Line high resolution

PRODUCT SPECIFICATION

Power	Power from CCTV distributor
Image sensor	1/3" SONY 960H SUPER HAD II CCD
Min. Illumination	0.1Lux at F1.2
Wiring	CCTV distributor-to-CCTV cameras : UTP
Dimension (mm)	Ø150×88.5(H)

GUARD STATION
CDS-481L



PRODUCT FUNCTION

- Paging and Calling with Household
- Calling for Lobby
- Checking and Setting out in Household
- Exchanging Calls between Household

PRODUCT SPECIFICATION

Power source	AC 100V-220V, 50/60Hz
Mount type	Desktop
Distance	1 km (0.65Ø)
Dimension (mm)	328(W)×230(H)×97(D)

FINE VIEW DISTRIBUTOR
CMD-404CFU



PRODUCT FUNCTION

- All UTP Wiring Floor distributor
- Connectable with Video Phone up to 4ea
- Connectable with FINE VIEW monitor(CDV)
- Only connectable with Entrance station (CMP panel)

PRODUCT SPECIFICATION

Power source	DC 24V, 1A
Wiring	-Household unit-to-Floor distributor : UTP -Floor distributor-to-Floor distributor : UTP
Mount type	Din-Rail Mounted type
Dimension(mm)	106(W)×76(H)×44(D)

FLOOR DISTRIBUTOR (DC TYPE)
CMD-404FUD



PRODUCT FUNCTION

- All UTP Wiring Floor distributor
- Connectable with Video Phone up to 4ea
- Connectable with DC type Video Phone up to 4ea

PRODUCT SPECIFICATION

Power source	DC 24V, 1A(From Building distributor)
Wiring	-Household unit-to-Floor distributor : UTP -Building distributor-to-Floor distributor : UTP -Floor distributor-to-Floor distributor : UTP
Mount type	Din-Rail Mounted type
Dimension (mm)	106(W)×76(H)×44(D)

HOUSEHOLD DISTRIBUTOR
CMD-104HU/108HU

NEW

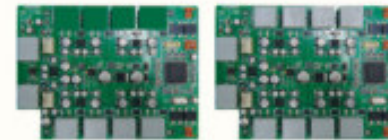

PRODUCT FUNCTION

- All UTP Wiring Household distributor
- Connectable with 8 monitors
- 4ports / 8ports (Connectable with Video Phone up to 4ea / 8ea)

PRODUCT SPECIFICATION

Power source	DC 24V, 1A
Wiring	-Household distributor-to-Floor distributor : UTP -Household distributor-to-Household unit : UTP -Household distributor-to-Camera : UTP
Mount type	Din-Rail Mounted type

GUARD STATION
CDS-2AG



PRODUCT FUNCTION

- Setting a Floor Distributor
- Changing a Bldg No, Household No, PIN number
- Paging and calling household
- Calling for lobby

PRODUCT SPECIFICATION

Power source	DC 12V, 1A
Mount type	Desktop
Wiring	Building distributor-to-Security office : UTP
Distance	Max. 1Km
Dimension (mm)	201(W)×230(H)×97(D)

PORTER PHONE
AP-3SG(PORTER)



PRODUCT FUNCTION

- Talk and doorlock release enabled (both individual and public entrance)
- Security office call enabled

PRODUCT SPECIFICATION

Power source	AC 100V, 110V, 220V, 50/60Hz
Mount type	Wall-mounted type
Wiring	Building distributor-to-Porter : UTP
Dimension (mm)	94(W)×185(H)×38(D)

SMART GATE SYSTEM

SMART GATE SYSTEM IS A COST-EFFECTIVE HOME NETWORK SYSTEM, PROVIDES AN INTEGRATED MANAGEMENT WITH SIMPLE INSTALLATION -NO SERVER IMPLEMENTATION REQUIRED.



FIELD OF SMART GATE SYSTEM APPLICATION

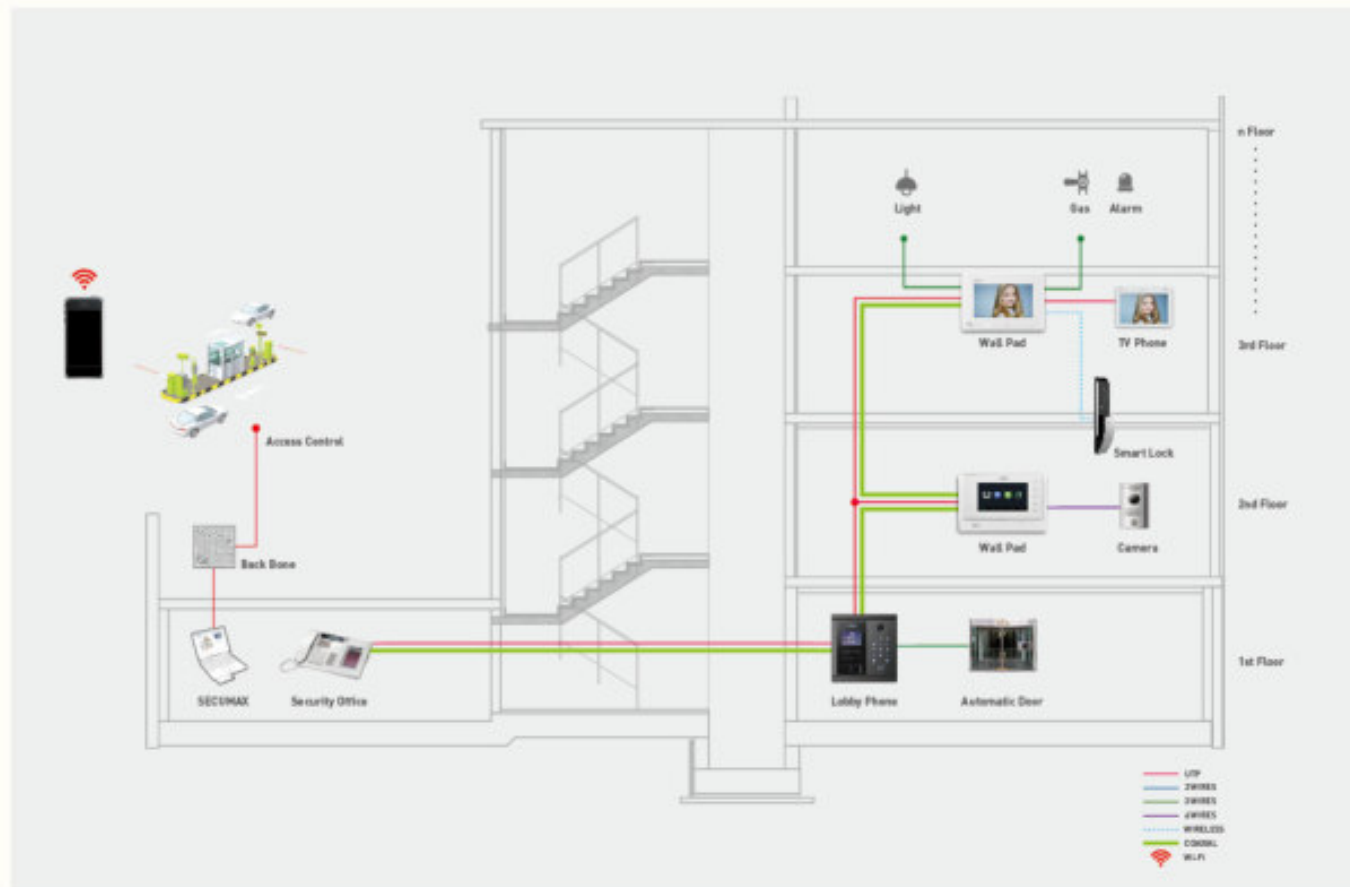

MONITOR CAV-705MX

NEW



PRODUCT FUNCTION

- Guard talk 3ch • Elevator call • Storing visitor video
- 7 inch LED Display • Guard call & talk
- Video talk and doorlock release enable (both individual and public entrance)
- Connects to IoT devices • Link with smart phone(Call, Talk, Control)

PRODUCT SPECIFICATION

Power source	AC 100-240V, 50/60Hz
Mount type	Flush mounted type
Operating temp.	0°C-40°C
Wiring	UTP(CAT. 5e)
Consumption	Max.15W
Distance	Lobby phone : 300m / Security office : 1Km
Dimension(mm)	244(W)×180(H)×20(50)(D)

MONITOR CDP-1020ID



PRODUCT FUNCTION

- 10.1 inch TFT LED display • DID function
- Touch-screen with user-friendly GUI application
- Security function & Light control • Energy management system
- Users can connect remotely via their smart phones(Secumax)

PRODUCT SPECIFICATION

Power source	DC14V, 1.8A
Power consumption	Standby : 560mA, Max.: 1.4A
Mount type	Flush-mounted type
Operating temp.	0°C-40°C
Wiring	Guard/Lobby : Common 10 wires+ 5C2V Coaxial cable(2 Wire) Door camera : 4 wires
Distance	Individual entrance : 50m(0.65Ø) / Guard station : 1km(0.65Ø) / Public entrance : 300m(5C2V)
Dimension(mm)	318(W)×215(H)×18(61)(D)

MONITOR CAV-705U/705UW



PRODUCT FUNCTION

- 7 inch TFT LED display • DID function
- Touch-screen with user-friendly GUI application
- Security function & Light control • Energy management system
- Users can connect remotely via their smart phones(Secumax)

PRODUCT SPECIFICATION

Power source	AC 100-240V, 50/60Hz
Power consumption	Standby : 6W, Max.: 16W
Mount type	CAV-705U : Built-in(Flush-mounted type) CAV-705UW : Wall-mounted type
Operating temp.	0°C-40°C
Wiring	Guard/Lobby : Common 10 wires+ 5C2V Coaxial cable(2 Wire) Door camera : 4 wires
Distance	Individual entrance : 50m(0.65Ø) / Guard station : 1km(0.65Ø) / Public entrance : 300m(5C2V)
Dimension(mm)	CAV-705U : 276(W)×178(H)×22(54)(D) CAV-705UW : 276(W)×178(H)×31(D)

MONITOR CAV-701M



PRODUCT FUNCTION

- Guard talk 3ch • Elevator call
- 7 inch LED Display • Guard call & talk • Security function
- Video talk and doorlock release enable (both individual and public entrance)
- Mirror front material applied(option)

PRODUCT SPECIFICATION

Power source	AC 100-240V, 50/60Hz
Mount type	Flush-mounted type
Operating temp.	0°C-40°C
Wiring	UTP(CAT. 5e)
Consumption	Max.15W
Distance	Lobby phone : 300m / Security office : 1Km
Dimension(mm)	244(W)×180(H)×20(50)(D)

MONITOR CAV-70HS

NEW



PRODUCT FUNCTION

- 7 inch LED Display • Home Network/ Home Automation slave Phone
- Video talk and doorlock release enabled (both individual and public entrance)
- Mirror front material applied

PRODUCT SPECIFICATION

Power source	AC 100-240V, 50/60Hz
Mount type	Wall-mounted type
Operating temp.	0°C~40°C
Wiring	6 wires
Consumption	12W (Max)
Distance	Monitor : 30m (0.65Ø)
Dimension(mm)	180(W)×180(H)×28(D)

ENTRANCE STATION DRC-703LC/RF1



PRODUCT FUNCTION

- Page and call a household unit or a security guard station
- Various verification methods(PIN number/RFID card)
- Expandable up to 99 units of DRC-703 LC/RF1
- Mirror view of a visitor enabled when paging

PRODUCT SPECIFICATION

Power source	DC 12V, 1A
Mount type	Flush-mounted type
Operating temp.	-10°C~+40°C
Wiring / Distance	UTP(CAT. 5e) / Max.300m
RFID card	13.56Mhz
Min. Illumination	0.3Lux
Dimension(mm)	244(W)×270(H)×17(43)(D)

ENTRANCE STATION DRC-7MBL/RF1



PRODUCT FUNCTION

- Metal is applied for front material
- BLE recognition • 3.5 inch LED Display
- Page and call a household unit or a security guard station
- Embedded RFID

PRODUCT SPECIFICATION

Power source	DC 12V, 1A
Mount Type	Flush-mounted type
Operating temp.	-20°C~+50°C
Wiring	UTP(CAT. 5e)
RFID card	13.56Mhz(optional)
Angle of view	Horiz.: 81°, Vert.: 66°
Dimension(mm)	250(W)×255(H)×7(36)(D)

GUARD STATION CDS-481L



PRODUCT FUNCTION

- Paging and calling a household
- Calling for lobby
- Checking and Setting out in household
- Exchanging calls between household

PRODUCT SPECIFICATION

Power source	AC 100V~220V, 50/60Hz
Power consumption	Max. : 7W
Mount type	Desktop
Operating temp.	0°C~40°C
Wiring	UTP(Cat. 5e)
Distance	1Km (0.65Ø)
Dimension(mm)	328(W)×230(H)×97(D)

GATE VIEW SYSTEM

GATE VIEW SYSTEM IS OPTIMIZED FOR SMALL AND MEDIUM SIZED APARTMENT COMPLEXES. IT PROVIDES A SAFER AND MORE CONVENIENT ENVIRONMENT.



FIELD OF GATE VIEW SYSTEM APPLICATION

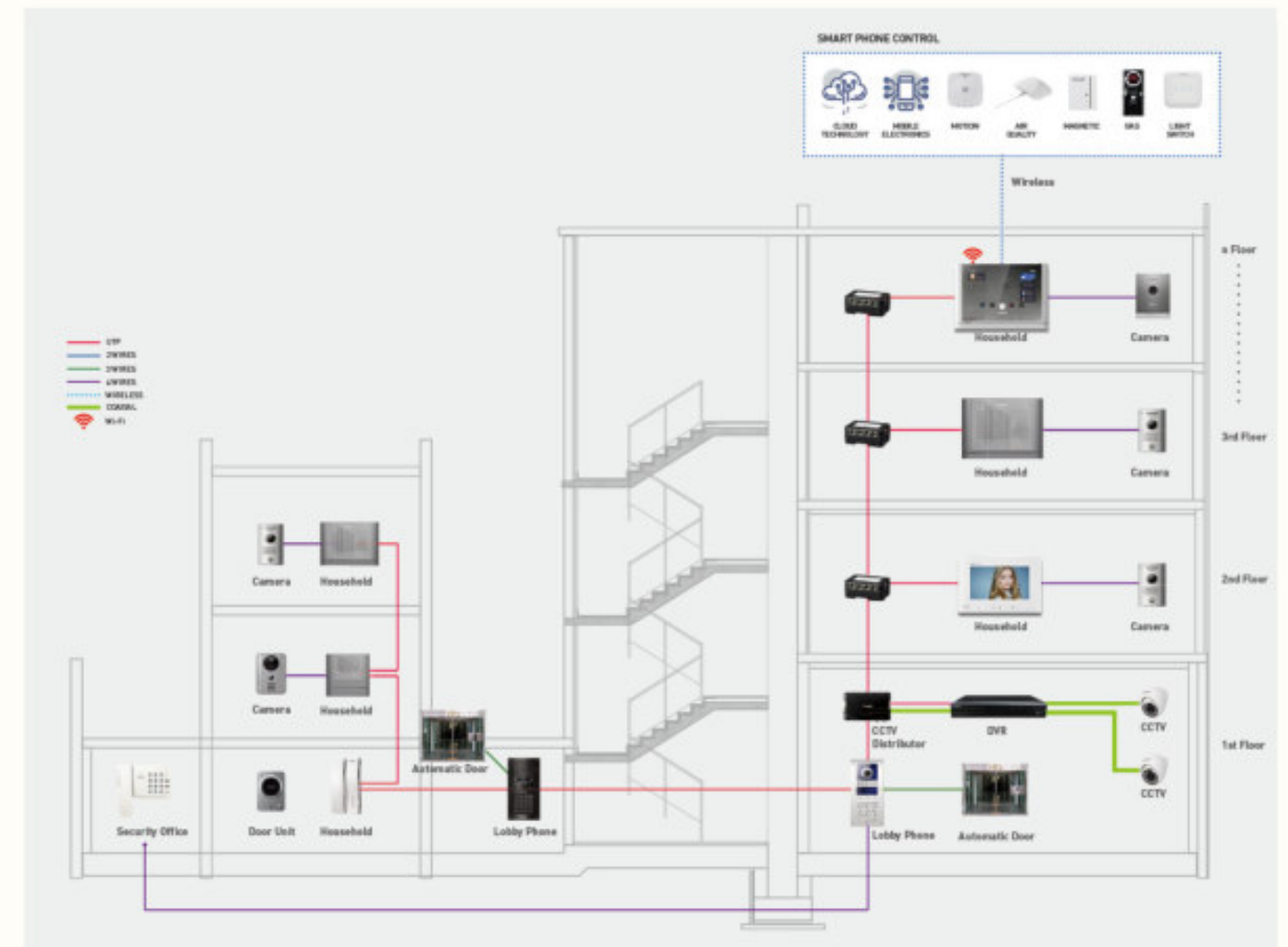

MONITOR CAV-1020MGX+ / 1021MGX+

IoT



PRODUCT FUNCTION

- Connects to IoT devices • Link with smart phone(Call, Talk, Control)
- Electric, lighting, gas remote control (wired or wireless) • Real-time CCTV monitoring through DVR • Elevator call function • Guard call & talk
- Storing visitor video • Connectable with slave phone

PRODUCT SPECIFICATION

Power source / Consumption	DC 14V / 18W (MAX)
Mount type	CAV-1020MGX+ : Flush-mounted type CAV-1021MGX+ : Wall-mounted type
Operating temp.	0°C~40°C
Wiring	UTP(CAT. 5e)
Distance	Lobby phone : 300m / Security office : 1Km
Protocol	Wi-Fi 2.4Ghz, IEEE 802.15.4, Zigbee HA 1.2(Compatible)
Dimension(mm)	CAV-1020MGX+ : 308(W)x213(H)x33(D) CAV-1021MGX+ : 308(W)x213(H)x25(D)

MONITOR CAV-1020IG+



PRODUCT FUNCTION

- CCTV Monitoring with VD-202G+ (Expandable up to 8 CCTV cameras)
- 10.1 inch LED Display • Guard call & talk • OSD • Elevator call function
- Video talk and doorlock release enable (both individual and public entrance)
- Prevention of fire disaster and crime

PRODUCT SPECIFICATION

Power source	AC 100~240V, 50/60Hz
Mount type	Wall-mounted type
Operating temp.	0°C~40°C
Wiring	UTP(CAT. 5e)
Consumption	Max. : 15W
Distance	Lobby phone : 300m / Security office : 1Km
Dimension(mm)	318(W)x215(H)x36(D)

MONITOR CAV-70MGX+

IoT



PRODUCT FUNCTION

- Connects to IoT devices • Link with smart phone(Call, Talk, Control)
- 7 inch full touch Display • Electric, lighting, gas remote control (wired or wireless) • Real-time CCTV monitoring through DVR
- Elevator call function • Guard call & talk • Storing visitor video

PRODUCT SPECIFICATION

Power source / Consumption	AC 100-240V, 50/60Hz / 15W (MAX)
Mount type	Wall-mounted type
Operating temp.	0°C~40°C
Wiring	UTP(CAT. 5e)
Distance	Lobby phone : 300m / Security office : 1Km
Protocol	Wi-Fi 2.4Ghz, IEEE 802.15.4, Zigbee HA 1.2(Compatible)
Dimension(mm)	244(W)x180(H)x18(D)

MONITOR CAV-70MG+



PRODUCT FUNCTION

- CCTV Monitoring with VD-202G+ (Expandable up to 8 CCTV cameras)
- Mirror front material applied(option) • Elevator call function
- 7 inch LED Display • Guard call & talk
- Video talk and doorlock release enable (both individual and public entrance)

PRODUCT SPECIFICATION

Power source	AC 100-240V, 50/60Hz
Mount type	Wall-mounted type
Operating temp.	0°C~40°C
Wiring	UTP(CAT. 5e)
Consumption	Max.15W
Distance	Lobby phone : 300m / Security office : 1Km
Dimension(mm)	244(W)x180(H)x18(D)

MONITOR CAV-70MHG



PRODUCT FUNCTION

- Mirror front material applied(option)
- 7 inch LED Display
- Video talk and doorlock release enable (both individual and public entrance)
- OSD • Guard call & talk

PRODUCT SPECIFICATION

Power source	AC 100-240V, 50/60Hz
Mount type	Wall-mounted type
Operating temp.	0°C~40°C
Wiring	UTP(CAT. 5e)
Consumption	Max.15W
Distance	Lobby phone : 300m / Security office : 1Km
Dimension(mm)	293(W)x180(H)x34(D)

MONITOR CAV-70MG2

NEW



PRODUCT FUNCTION

- 7 inch LED Display • Guard call & talk
- Elevator call function
- Mirror front material applied(option)
- Video talk and doorlock release enable (both individual and public entrance)

PRODUCT SPECIFICATION

Power source	AC 100-240V, 50/60Hz
Mount type	Wall-mounted type
Operating temp.	0°C~40°C
Wiring	UTP(CAT. 5e)
Consumption	Max.15W
Distance	Lobby phone : 300m / Security office : 1Km
Dimension(mm)	244(W)x180(H)x18(D)

MONITOR CAV-70MG



PRODUCT FUNCTION

- Mirror front material applied(option)
- 7 inch LED Display
- Video talk and doorlock release enable (both individual and public entrance)
- Guard call & talk • OSD

PRODUCT SPECIFICATION

Power source	AC 100-240V, 50/60Hz
Mount type	Wall-mounted type
Operating temp.	0°C~40°C
Wiring	UTP(CAT. 5e)
Consumption	Max.15W
Distance	Lobby phone : 300m / Security office : 1Km
Dimension(mm)	244(W)x180(H)x18(D)

MONITOR CAV-43MHG



PRODUCT FUNCTION

- Mirror front material applied(option)
- 4.3 inch LED Display
- Video talk and doorlock release enable (both individual and public entrance)
- Guard call & talk • OSD

PRODUCT SPECIFICATION

Power source	AC 100-240V, 50/60Hz
Mount type	Wall-mounted type
Operating temp.	0°C~40°C
Wiring	UTP(CAT. 5e)
Consumption	Max.15W
Distance	Lobby phone : 300m / Security office : 1Km
Dimension(mm)	230(W)x180(H)x41(D)

MONITOR
CAV-43MG



PRODUCT FUNCTION

- Mirror front material applied(option)
- 4.3 inch LED Display • Guard call & talk • OSD
- Video talk and doorlock release enable (both individual and public entrance)

PRODUCT SPECIFICATION

Power source	AC 100-240V, 50/60Hz
Mount type	Wall-mounted type
Operating temp.	0°C~40°C
Wiring	UTP(CAT. 5e)
Consumption	Max.15W
Distance	Lobby phone : 300m / Security office : 1Km
Dimension(mm)	180(W)×180(H)×28(D)

MONITOR
CAV-43MG2

NEW



PRODUCT FUNCTION

- 4.3 inch LED Display • Guard call & talk
- Elevator call function • Mirror front material applied(option) • Video talk and doorlock release enable (both individual and public entrance)

PRODUCT SPECIFICATION

Power source	AC 100-240V, 50/60Hz
Mount type	Wall-mounted type
Operating temp.	0°C~40°C
Wiring	UTP(CAT. 5e)
Consumption	Max.15W
Distance	Lobby phone : 300m / Security office : 1Km
Dimension(mm)	180(W)×180(H)×28(D)

ENTRANCE STATION
DRC-7MBL/RF1



PRODUCT FUNCTION

- Metal is applied for front material • 3.5 inch Display • Page and call a household unit or a security guard station • Expandable up to 99 units of DRC-7MBL/RF1

PRODUCT SPECIFICATION

Power source	DC 12V, 1A
Mount Type	Flush-mounted type
Operating temp.	-20°C~+50°C
Wiring	UTP(CAT. 5e)
Distance	Max.300m
RFID card	13.56Mhz
Dimension(mm)	250(W)×255(H)×7(36)(D)

ENTRANCE STATION
DRC-8TML



PRODUCT FUNCTION

- RF card registration and deletion possible (125KHz or 13.56MHz) • 24Direct buttons panel(DRC-24XM)expansibility • 8direct buttons & 10key • BLE (Door open) • OLED • Pinhole camera

PRODUCT SPECIFICATION

Power source	DC12V/1A
Operation Temp.	-20°C~+40°C
Mount type	Flush-mounted type
Wiring	UTP
Min. Illumination	0.1Lux(up to 300mm)
Camera view angle	Horiz. : 75°, Vert. : 55°
Dimension(mm)	130(W)×315(H)×10(D)

EXTENSION PANEL
DRC-24XM



PRODUCT FUNCTION

- 24 Direct buttons call Extension panel (DRC-24XM)

PRODUCT SPECIFICATION

Power source	From DRC-8TML
Mount type	Flush-mounted type
Operating temp.	-20°C~+40°C
Wiring	UTP(to DRC-8TML)
Dimension (mm)	130(W)×315(H)×10(D)

ENTRANCE STATION
DRC-900LC/RF1



PRODUCT FUNCTION

- Vandal-proof aluminium die-casting case • Hidden Pinhole camera • IR sensor type anti-freezing buttons • Paging and calling a household unit or a security guard station • OLED

PRODUCT SPECIFICATION

Power source	DC 12V, 1A
Mount type	Flush-mounted type
Operating temp.	DRC-900LC : -40°C~+60°C DRC-900LC/RF1 : -20°C~+60°C
Wiring	UTP(Cat. 5e)
RFID card	13.56MHz(optional)
Dimension(mm)	136(W)×260(H)×36(D)
Rain-shield(mm)	140(W)×260(H)×65(D)

ENTRANCE STATION
DRC-703LC/RF1



PRODUCT FUNCTION

- Page and call a household unit or a security guard station • Various verification methods (PIN number and RFID card)
- Expandable up to 99 units of DRC-703 LC/RF1

PRODUCT SPECIFICATION

Power source	DC 12V, 1A
Mount type	Flush-mounted type
Wiring	Building Distributor : UTP
RFID card	13.56Mhz(optional)
Angle of view	Horiz.: 68°, Vert.: 55°
Operating temp.	-40°C~+40°C
Dimension (mm)	244(W)×270(H)×17(43)(D)

AUDIO PHONE
AP-3SG



PRODUCT FUNCTION

- Talk and doorlock release enabled(both individual and public entrance)
- Security office call enabled

PRODUCT SPECIFICATION

Power source	AC 110, 220, 240V, 50/60Hz
Mount type	Wall-mounted type
Operating temp.	0°C~40°C
Wiring	Common : UTP(Cat. 5e) Door camera : 3 wires
Distance	Lobby phone : 300m , Security office : 1Km
Dimension(mm)	94(W)×185(H)×38(D)

ENTRANCE STATION
DRC-GUC/RF1



PRODUCT FUNCTION

- Paging and calling a household unit or a security guard station • OLED
- Various verification methods (password and RFID card)

PRODUCT SPECIFICATION

Power source	DC 12V, 1A
Mount type	Flush-mounted type
Operating temp.	-10°C~+40°C
Wiring	UTP(Cat. 5e)
Resolution	380TVL or 540TVL
Angle of view	Horiz.: 68°, Vert. : 55°
Dimension(mm)	130(W)×315(H)×10(38)(D)

GUARD STATION
CDS-4GS



PRODUCT FUNCTION

- Simple-to-use phone optimized for security station, exclusively for gate view. • Paging and calling a household • Calling lobby phone
- Releasing doorlock of public entrance

PRODUCT SPECIFICATION

Power source	DC 12V, 1A
Power consumption	Max. : 2W
Mount type	Wall-mounted type / Desktop
Operating temp.	0°C~40°C
Wiring	UTP(Cat. 5e)
Distance	Max. 1Km
Dimension(mm)	196(W)×130(H)×51(D)

DISTRIBUTOR
CCU-4GF



PRODUCT FUNCTION

- Enables "STAR" wiring method for Gate View monitor connections
- CCU-4GF-to-CCU-4GF enabled to expand up to 40 units limited to 300 meters

PRODUCT SPECIFICATION

Power	DC 12V, 1A
Mount type	Wall-mounted type
Transmission	Lobby 8 Lines(Polarity) (RJ45 CAT.5e Patch Cable)
Distance	Maximum 300m (Possible to connect Max 40 units)
Dimension(mm)	106(W)×76(H)×44(D)

ELEVATOR CONNECTOR
CCU-310EV



PRODUCT FUNCTION

- Able to call from Lobbyphone and Monitor (Lobby mode / Unit mode) • Unit mode : Able to set up to 630 units or 80 floors • Lobby mode : Able to set up to 89 Lobbyphones

PRODUCT SPECIFICATION

Power	DC 12V, 1A
Mount type	Wall-mounted type, DIN rail type
Wiring	DATA : 2wire Elevator S/W : 2wire x 10port
Distance	1km (0.650)
Dimension(mm)	157(W)×86(H)×59(D)

AUDIO GATE SYSTEM (2 WIRES&UTP)

COMMAX AUDIO GATE SYSTEM IS OPTIMIZED FOR MULTI-COMPLEX APARTMENTS AND BUILDINGS. IT ALSO PROVIDES A SIMPLE INSTALLATION METHOD AND EXPANDABILITY FOR COST-EFFECTIVE IMPLEMENTATION.



FIELD OF AUDIO GATE SYSTEM APPLICATION

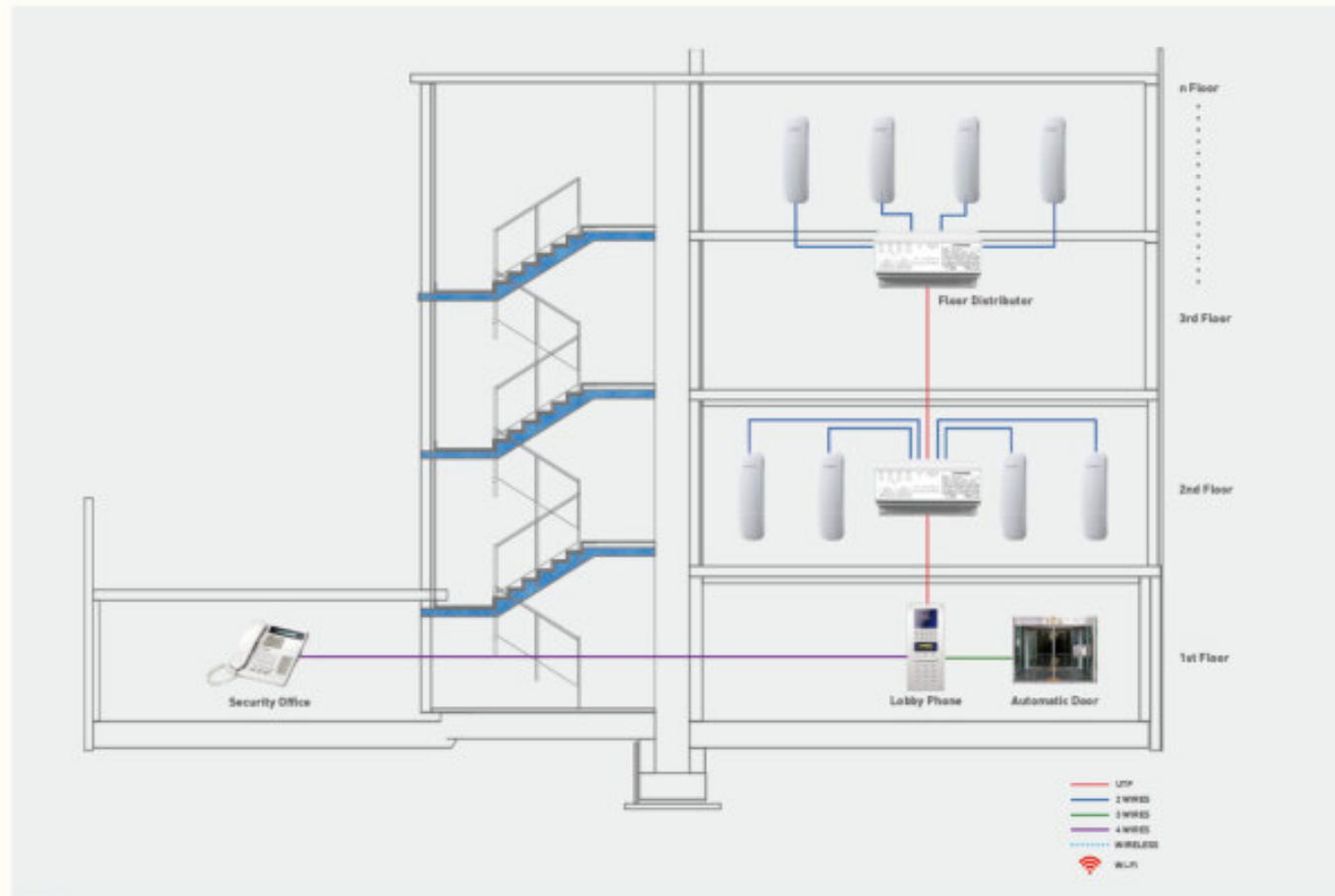

ENTRANCE STATION DR-2AG/RF1



PRODUCT FUNCTION

- Expandability Up to 4-1,000 household units (Up to 3 RFID Card registration perhousehold enabled)

PRODUCT SPECIFICATION

Power Source	DC 12V, 1A
Consumption	Standby: 400mA, Max.: 500mA
RFID Card	13.56MHz (optional)
Mount Type	Flush-mounted type
Wiring	Lobby phone-to-floor distributor : 1 UTP Household unit-to-floor distributor : 2 wires
Dimension(mm)	130(W)x315(H)x10(38)(D)

AUDIO DOOR UNIT DR-2GS

NEW



PRODUCT FUNCTION

- Vandal proof
- Guard call and talk

PRODUCT SPECIFICATION

Power source	DC 12V (from Guard Phone)
Mount type	Wall-mounted type
Operation Temp.	-40°C~50°C
Wiring	6wires
Dimension(mm)	87(W)x120(H)x20(D)

DOORPHONE AP-2SAG



PRODUCT FUNCTION

- 2 wire connection with non-polarity from a floor distributor
- Talk with a visitor and doorlock release enable
- Power source : floor distributor

PRODUCT SPECIFICATION

Power source	From floor distributor
Wiring	2 wires with non-polarity
Distance	100m (0.65Ø)
Operating Temp.	0°C~40°C
Dimension(mm)	70(W)x210(H)x60(D)

GUARD STATION CDS-2AG



PRODUCT FUNCTION

- Household unit call
- Lobby phone call
- CID function for a calling household identification
- 1UTP cabling for a simple installation from floor distributor

PRODUCT SPECIFICATION

Power source	DC 12V, 1A
Mount type	Desktop
Wiring	Building distributor-to-Guard Station : UTP
Distance	Max. 1km
Dimension(mm)	230(W)x200(H)x35(D)

FLOOR DISTRIBUTOR CCU-204AGF/208AGF

NEW



PRODUCT FUNCTION

- 2 wire connection with non-polarity
- Provides the power to each household units
- 1UTP cabling between floor distributors

PRODUCT SPECIFICATION

Power source	DC 24V, 3A
Port	4(8) channel (Connectable with 2 wire Audio phone up to 4 ea)
Wiring	-Lobby panel-to-Floor distributor : UTP -Household unit-to-Floor distributor : 2 wires -Floor distributor-to-Floor distributor : UTP

FLOOR DISTRIBUTOR CCU-216AGF/232AGF

NEW



PRODUCT FUNCTION

- 2 wire connection with non-polarity
- Provides the power to each household units
- 1UTP cabling between floor distributors

PRODUCT SPECIFICATION

Power source	DC 24V, 3A
Port	16(32) channel (Connectable with 2 wire Audio phone up to 4 ea)
Wiring	-Lobby panel-to-Floor distributor : UTP -Household unit-to-Floor distributor : 2 wires -Floor distributor-to-Floor distributor : UTP

FINE VIEW

FINE VIEW IS THE WORLD BEST SELLING VIDEOPHONE. IT PROVIDES CLEAR VIDEO QUALITY THROUGH SPECIALIZED 'FINEVIEW' TECHNOLOGY OF COMMAX



MONITOR CDV-1024MA

NEW



PRODUCT FUNCTION

- 10.1 inch LED Display(1024 X 600), Full touch display
- Security function (Security sensor 1,2)
- Connecting 2 individual door camera & 2 CCTV (Call from individual door camera, all monitor will be displayed.)
- Intercommunicate between monitors(Page & Call) (All master & each monitor has its own ID.) (Can't connect with DP-4VHP)
- Saving image & movie clip (Without Micro SD, only image can be saved, With Micro SD, image & movie clip can be saved.)
- Motion detection and image saving(Optional)
- CCTV Monitoring for main entrance • DVR function with SD card (256G)
- AHD 2mega solution

PRODUCT SPECIFICATION

Power source	AC 100-240V, 50/60Hz
Display	10.1 inch wide color LCD
Mount type	Wall-mounted type
Operating temp.	0°C~40°C
Wiring	Door camera : 4 wires Interphone : 4 wires CCTV : 2 wires
Distance	Door camera : 50m(0.65Ø)
Consumption	Max.10W, standby 3.4W
Dimension(mm)	308(W)x213(H)x23(D)

FIELD OF FINE VIEW APPLICATION

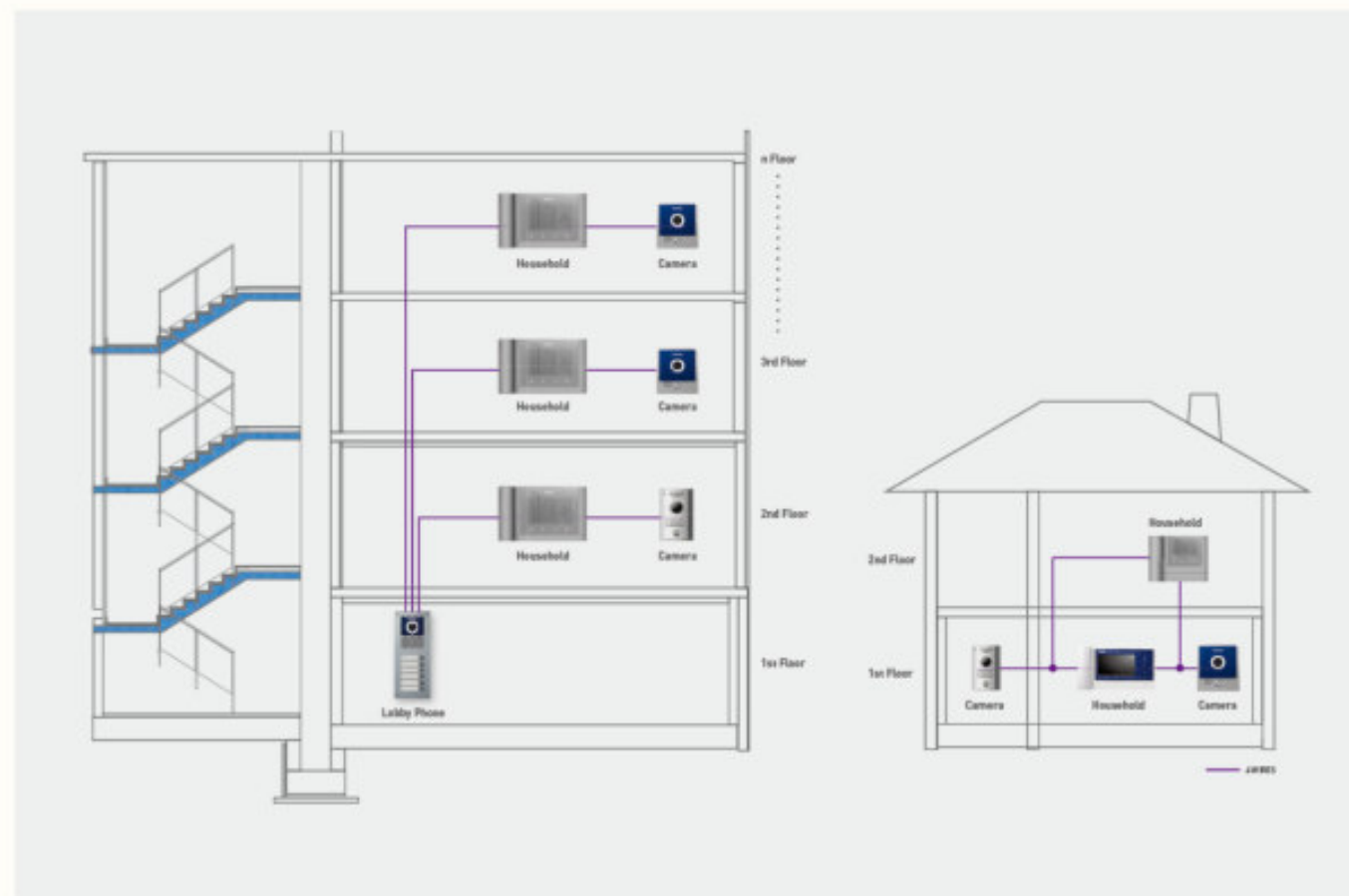

MONITOR CDV-704MA



PRODUCT FUNCTION

- 7 inch LED Display(1024 X 600), Full touch display
- Connecting 2 individual door camera & 2 CCTV (Call from individual door camera, all monitor will be displayed.)
- Intercommunicate between monitors(Page & Call) (All master & each monitor has its own ID.) (Can't connect with DP-4VHP)
- Saving image & movie clip (Without Micro SD, only image can be saved, With Micro SD, image & movie clip can be saved.)
- Motion detection and image saving(Optional)
- CCTV Monitoring for main entrance
- AHD 1.3mega solution

PRODUCT SPECIFICATION

Power source	AC 100-240V, 50/60Hz
Display	7inch wide color LCD
Mount type	Wall-mounted type
Operating temp.	0°C~40°C
Wiring	Door camera : 4 wires Interphone : 4 wires CCTV : 2 wires
Distance	Door camera : 50m(0.65Ø)
Consumption	Max.10W, standby 3.4W
Dimension(mm)	244(W)x180(H)x18(D)

MONITOR
CDV-70MH / 70MHM

NEW



PRODUCT FUNCTION

- Mirror front material applied(option) • 7 inch TFT LED Display
- Video talk and doorlock release enable • PAL/NTSC convertible
- Support 2 Monitors, 2 Cameras and 2 Interphones
- Memory storing in Micro SD memory (SD Card is not included CDV-70MHM)

PRODUCT SPECIFICATION

Power source	AC 100-240V, 50/60Hz
Mount type	Wall-mounted type
Operating temp.	0°C~40°C
Wiring	Door camera : 4wires / Interphone : 4wires
Distance	Door camera : 28m (0.5Ø) / Interphone : 30m(0.65Ø)
Consumption	Max.10W/standby 3.4W
Dimension(mm)	293(W)×180(H)×34(D)

MONITOR(MOTION DETECTION)
CDV-71UM



PRODUCT FUNCTION

- 7 inch TFT LED Full touch screen
- Video talk and doorlock release enable • Memory storing in SD memory
- Expandable up to 2 monitors with 2 CCTV cameras, 2 door cameras and 2 interphones • CCTV Camera motion detection & Recording

PRODUCT SPECIFICATION

Power source	AC 100-240V, 50/60Hz
Mount type	Wall-mounted type
Operating temp.	0°C~40°C
Wiring	Door camera : 4 wires / Interphone : 4 wires CCTV camera : 2 wires
Distance	Door camera : 28m (0.5Ø) / Interphone : 30m(0.65Ø)
Dimension(mm)	276(W)×185(H)×33(D)

MONITOR
CDV-70M



PRODUCT FUNCTION

- 7 inch TFT LCD screen • PAL/NTSC convertible
- Video talk and doorlock release enable (both individual and public entrance)
- Support 2 Monitors, 2 Cameras and 2 Interphones

PRODUCT SPECIFICATION

Power source	AC 100-240V, 50/60Hz
Mount type	Wall-mounted type
Operating temp.	0°C~40°C
Wiring	Door camera : 4 wires / Interphone : 4 wires
Distance	Door camera : 28m (0.5Ø) / Interphone : 30m(0.65Ø)
Consumption	Max.10W/standby 3.4W
Dimension(mm)	244(W)×180(H)×18(D)

MONITOR(MOTION DETECTION)
CDV-72UM



PRODUCT FUNCTION

- Store video&still image through real-time monitoring & motion detection
- Memory storing in SD card • Full touch screen
- Expandable up to 2 monitors with 2 CCTV cameras and 2 door cameras
- Video talk and doorlock release enable

PRODUCT SPECIFICATION

Power source	AC 100-240V, 50/60Hz
Mount type	Wall-mounted type
Operating temp.	0°C~40°C
Wiring	Door camera : 4 wires / Interphone : 4 wires CCTV camera : 2 wires
Distance	Door camera : 28m (0.5Ø) / Interphone : 30m(0.65Ø)
Dimension(mm)	276(W)×185(H)×33(D)

MONITOR
CDV-43K/43K2/43KM



PRODUCT FUNCTION

- Support 2 monitors, 1 camera and 2 Interphones(CDV-43K)
- Support 2 monitors, 2 cameras and 2 Interphones(CDV-43K2)
- Intercommunication with sub monitor and interphone.
- Built-in memory storing in SD memory (SD Card is not included CDV-43KM)

PRODUCT SPECIFICATION

Power source	AC 100-240V, 50/60Hz
Mount type	Wall-mounted type
Operating temp.	0°C~40°C
Wiring	Door camera : 4 wires / Interphone : 4 wires
Distance	Door camera : 28m (0.5Ø) / Interphone : 30m(0.65Ø)
Dimension(mm)	157(W)×167(H)×28(D)

MONITOR
CDV-70H/70H2



PRODUCT FUNCTION

- 7 inch TFT LED display • Video talk and doorlock release enable
- Support 2 monitors, 1 cameras and 2 Interphones(CDV-70H)
- Support 2 monitors, 2 cameras and 2 Interphones(CDV-70H2)
- PAL/NTSC convertible • Intercommunication with sub monitor and interphone

PRODUCT SPECIFICATION

Power source	AC 100-240V, 50/60Hz (FREE VOLTAGE)
Mount type	Wall-mounted type
Operating temp.	0°C~40°C
Wiring	Door camera : 4 wires / Interphone : 4 wires
Distance	Door camera : 28m (0.5Ø) / Interphone : 30m(0.65Ø)
Dimension(mm)	180(W)×180(H)×28(D)

MONITOR
CDV-70N/70N2/70NM



PRODUCT FUNCTION

- Video talk and doorlock release enable • Handset type design
- Expandable up to 1 door camera, 2 monitors and 2 interphones (CDV-70N)
- Expandable up to 2 monitors, 2 door cameras and 2 interphones (CDV-70N2)
- Memory storing in Micro SD memory (SD Card is not included CDV-70NM)

PRODUCT SPECIFICATION

Power source	AC 100-240V, 50/60Hz
Mount type	Wall-mounted type
Operating temp.	0°C~40°C
Wiring	Door camera : 4 wires / Interphone : 4 wires
Distance	Door camera : 28m (0.5Ø) / Interphone : 30m(0.65Ø)
Dimension(mm)	230(W)×180(H)×28(D)

MONITOR(3 DOOR OPEN)
CDV-70AR3



PRODUCT FUNCTION

- 7 inch TFT LED display • Video talk and doorlock release enabled
- Door release enabled by monitoring(without visitor's call)
- 3 Door release function(front door, garage, back door)
- Support 2 Monitors, 2 Cameras, and 2 Interphones

PRODUCT SPECIFICATION

Power source	AC 100-240V, 50/60Hz
Mount type	Wall-mounted type
Operating temp.	0°C~40°C
Wiring	Door camera:4wires/ Subinterphone:4wires Door open :front door back door 2 wires / garage 3 wires
Distance	Door camera : 28m (0.5Ø) / Interphone : 30m(0.65Ø)
Dimension(mm)	243(W)×168(H)×35(D)

MONITOR CDV-43MH



PRODUCT FUNCTION

- Mirror front material applied
- 4.3 inch TFT LED display
- Video talk and doorlock release enable
- Support 2 Monitors, 2 Cameras and 2 Interphones
- PAL/NTSC convertible

PRODUCT SPECIFICATION

Power source	AC 100-240V, 50/60Hz
Mount type	Wall-mounted type
Operating temp.	0°C~40°C
Wiring	Door camera : 4wires / Interphone : 4wires
Distance	Door camera : 28m (0.5Ø) / Interphone : 30m(0.65Ø)
Dimension(mm)	230(W)×180(H)×41(D)

MONITOR CDV-43M



PRODUCT FUNCTION

- 4.3 inch TFT LCD screen
- Video talk and doorlock release enable (both individual and public entrance)
- Support 2 Monitors, 2 Cameras and 2 Interphones
- PAL/NTSC convertible

PRODUCT SPECIFICATION

Power source	AC 100-240V, 50/60Hz
Mount type	Wall-mounted type
Operating temp.	0°C~40°C
Wiring	Door camera : 4wires / Interphone : 4wires
Distance	Door camera : 28m (0.5Ø) / Interphone : 30m(0.65Ø)
Dimension(mm)	180(W)×180(H)×28(D)

MONITOR CDV-70K/70KM



PRODUCT FUNCTION

- 7 inch TFT LCD screen
- Video talk and doorlock release enable
- Expandable up to 2 monitors with 2 CCTV cameras and 2 door cameras
- Memory storing in SD memory (CDV-70KM)

PRODUCT SPECIFICATION

Power source	AC 100-240V, 50/60Hz
Mount type	Wall-mounted type
Operating temp.	0°C~40°C
Wiring	Door camera : 4 wires / Interphone : 4 wires
Distance	Door camera : 28m (0.5Ø) / Interphone : 30m(0.65Ø)
Dimension(mm)	311(W)×168(H)×32(D)

MONITOR(3 DOOR OPEN) CDV-70KR3



PRODUCT FUNCTION

- Door release enabled by monitoring(without visitor's call)
- 3 Door release function(front door, garage, back door)
- Support 2 Monitors, 2 Cameras, and 2 Interphones

PRODUCT SPECIFICATION

Power source	AC 100-240V, 50/60Hz
Mount type	Wall-mounted type
Operating temp.	0°C~40°C
Wiring	Door camera : 4wires / Sub interphone: 4wires / Door open : front door back door 2 wires / garage 3 wires
Distance	Door camera : 50m(0.65Ø) / Interphone : 30m(0.65Ø)
Dimension(mm)	311(W)×168(H)×32(D)

MONITOR(PABX) CDV-70KT



PRODUCT FUNCTION

- Phone call enable during power failure
- Connectable with PABX
- DID function
- PAL/NTSC convertible

PRODUCT SPECIFICATION

Power source	AC 100-240V, 50/60Hz
Mount type	Wall-mounted type
Operating temp.	0°C~40°C
Wiring	Door camera : 4 wires / Telephone : 2 wires
Consumption	Max.16 W/Standby 4 W
Distance	Door camera : 50m(0.65Ø) / Interphone : 30m(0.65Ø)
Dimension(mm)	311(W)×168(H)×32(D)

MONITOR(PAN/TILT) CDV-70KPT

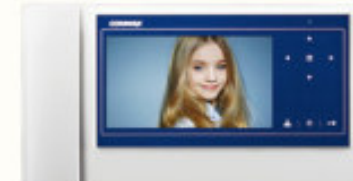

PRODUCT FUNCTION

- Digital Pan-Tilt(160° angle of view)
- Navigation buttons applied to maneuver display
- Support 2 Monitors, 2 Cameras and 2 Interphones
- PAL/NTSC convertible
- DRC-40KPT connectable

PRODUCT SPECIFICATION

Power source	AC 100-240V, 50/60Hz
Mount type	Wall-mounted type
Operating temp.	0°C~40°C
Wiring	Door camera : 4 wires / Interphone : 4 wires
Consumption	Max. 16W/standby 4.5W
Distance	Door camera : 50m(0.65Ø) / Interphone : 30m(0.65Ø)
Dimension(mm)	311(W)×168(H)×32(D)

DOORLOCK CAMERA DRC-40DK / 41DK

NEW



PRODUCT FUNCTION

- 2 Door open camera
- 3 way access (PW, RF Card, Video phone)
- Enter the password using 10key
- Illuminance sensor
- Out door unit
- House call and talk
- Motion detection (PIR)
- DRC-40DK : wall-mounted type
- DRC-41DK : Built-in type

PRODUCT SPECIFICATION

Power source	12VDC/1A (Adaptor)
Operation Temp.	-10°C(tested up to -40°C) ~ +50°C
Wiring	4 wires to a monitor / 2 wires to DOOR 1 3 wires to DOOR 2 (non-polarity)
Minimum Illumination	0.1Lux (up to 300mm)
Lighting	Built-in white LED (3 pie) 2 EA
Imaging angle	110° diagonal
Camera angle adjusting	Ascendant : 12° Descendant : 12°
Distance	28 meters (Ø 0.5 UTP), It must be observed.
Dimension(mm)	DRC-40DK : 127(W)×193(H)×54(D) DRC-41DK : 127(W)×193(H)×63(D)

DOOR CAMERA DRC-4CPN3

NEW



PRODUCT FUNCTION

- Built-in illumination sensor
- Outdoor model
- Surface-mounted type
- House call and talk

PRODUCT SPECIFICATION

Power source	12V(From monitor)
Operation Temp.	-40°C~+50°C
Wiring	4 wires
Lighting	Built-in white LED (3pie) 2 EA
Camera view angle	Horizontal 68° Vertical 55°
Distance	28m(0.5Ø) 50m(0.65Ø)
Dimension(mm)	58.7(W)×164(H)×42(D)

DOOR CAMERA DRC-4CPNK

NEW



PRODUCT FUNCTION

- Built-in illumination sensor
- Outdoor model
- Surface-mounted type
- 6 buttons
- House call and talk
- 2 door open(option)

PRODUCT SPECIFICATION

Power source	12V(From monitor / adaptor)
Operation Temp.	-40°C~+50°C
Wiring	4 wires
Lighting	Built-in white LED
Camera view angle	Horizontal 68° Vertical 55°
Distance	28m(0.5Ø) 50m(0.65Ø)
Dimension(mm)	58.7(W)×164(H)×42(D)

DOOR CAMERA DRC-4FC



PRODUCT FUNCTION

- Illuminance sensor • Out door model
- Surface-mounted type
- House call and talk
- Built-in white LED (3pie) 2 EA

PRODUCT SPECIFICATION

Power source	12V(From monitor)
Operation Temp.	-40°C~+50°C
Wiring	4 wires
Camera angle adjusting	Ascendant : 13° Descendant : 13°
Distance	28m(0.5Ø) 50m(0.65Ø)
Dimension(mm)	119(W)×178(H)×23(45)(D)

DOOR CAMERA DRC-4M



PRODUCT FUNCTION

- Built-in illumination sensor
- Metal is applied for front material
- House call and talk • Built-in white LED
- Flush mounted type

PRODUCT SPECIFICATION

Power source	12V(From monitor)
Operation Temp.	-40°C~+40°C
Wiring	4 wires
Camera angle adjusting	Ascendant : 10° Descendant : 10°
Distance	50m(0.65Ø)
Dimension(mm)	112.2(W)×146.2(H)×44.3(D)

DOOR CAMERA DRC-41M

NEW



PRODUCT FUNCTION

- Built-in illumination sensor
- House call and talk
- Built-in white LED
- Wall-mounted type

PRODUCT SPECIFICATION

Power source	12V(From monitor)
Operation Temp.	-40°C~+40°C
Wiring	4 wires
Camera angle adjusting	Ascendant : 10° Descendant : 10°
Distance	50m(0.65Ø)
Dimension(mm)	112.2(W)×146.2(H)×44.3(D)

DOOR CAMERA DRC-4U (BLUE/WHITE)



PRODUCT FUNCTION

- Illuminance sensor
- In door model
- Flush-mounted type
- House call and talk

PRODUCT SPECIFICATION

Power source	12V(From monitor)
Operation Temp.	-40°C~+40°C
Wiring	4 wires
Camera view angle	Ascendant : 10° Descendant : 10°
Distance	50m(0.65Ø)
Dimension(mm)	112.2(W)×146.2(H)×44.3(D)

DOOR CAMERA DRC-4CGN2



PRODUCT FUNCTION

- Illuminance sensor • Out door model
- Surface-mounted type
- House call and talk
- Built-in white LED

PRODUCT SPECIFICATION

Power source	12V(From monitor)
Operation Temp.	-40°C~+50°C
Wiring	4 wires
Camera view angle	Horizontal 47° Vertical 34°
Distance	28m(0.5Ø) 50m(0.65Ø)
Dimension(mm)	87(W)×120(H)×20(D)

DOOR CAMERA DRC-40K



PRODUCT FUNCTION

- Illuminance sensor • Out door model
- Surface-mounted type
- House call and talk
- Built-in white LED

PRODUCT SPECIFICATION

Power source	12V(From monitor)
Operation Temp.	-40°C~+40°C
Wiring	4 wires
Camera view angle	Horizontal 75° Vertical 55°
Distance	28m(0.5Ø) 50m(0.65Ø)
Dimension(mm)	96(W)×155(H)×32(D)

DOOR CAMERA DRC-41UN



PRODUCT FUNCTION

- Built-in illumination sensor
- Both indoor and outdoor use
- Flush-mounted type • Name plate
- House call and talk • Built-in white LED

PRODUCT SPECIFICATION

Power source	12V(From monitor)
Operation Temp.	-40°C~+50°C
Wiring	4 wires
Camera angle adjusting	Ascendant : 10° Descendant : 10°
Distance	50m(0.65Ø)
Dimension(mm)	130(W)×182(H)×10(39)(D)

DOOR CAMERA DRC-40KHD

NEW



PRODUCT FUNCTION

- Built-in illumination sensor
- Both indoor and outdoor use
- Wall-mounted type • House call and talk
- Built-in white LED • AHD 1.3M pixel

PRODUCT SPECIFICATION

Power source	12V(From monitor)
Operation Temp.	-40°C~+40°C
Wiring	4 wires
Camera angle adjusting	Ascendant : 12° Descendant : 12°
Distance	50m(0.65Ø)
Dimension(mm)	96(W)×155(H)×32(D)

DOOR CAMERA DRC-4CPHD

NEW



PRODUCT FUNCTION

- Built-in illumination sensor
- Both indoor and outdoor use
- Wall-mounted type • House call and talk
- Built-in white LED • AHD 1.3M pixel

PRODUCT SPECIFICATION

Power source	12V(From monitor)
Operation Temp.	-40°C~+50°C
Wiring	4 wires
Distance	50m(0.65Ø)
Dimension(mm)	58.7(W)×164(H)×42(D)

DOOR CAMERA (2 DOOR OPEN) DRC-40KR2



PRODUCT FUNCTION

- 2 Door open camera (CDV-70KR3/70AR3 Connectable)
- Illuminance sensor • Out door model
- Surface-mounted type • House call and talk
- Built-in white LED

PRODUCT SPECIFICATION

Power source	12V(From monitor)
Operation Temp.	-40°C~+40°C
Wiring	4 wires to a monitor DOOR1 release : 2 wires DOOR2 release : 3 wires
Camera angle adjusting	Ascendant : 12° Descendant : 12°
Distance	50m(0.65Ø)
Dimension(mm)	96(W)×155(H)×32(D)

DOOR CAMERA (MOTION DETECTION) DRC-40KA



PRODUCT FUNCTION

- Motion detection camera (CDV-72UM Connectable)
- Built-in illumination sensor • Built-in white LED
- Both indoor and outdoor use
- House call and talk • Surface-mounted type

PRODUCT SPECIFICATION

Power source	12V(From monitor)
Operation Temp.	-40°C~+40°C
Wiring	4 wires
Camera angle adjusting	Ascendant : 12° Descendant : 12°
Distance	50m(0.65Ø)
Dimension(mm)	96(W)×155(H)×32(D)

DOOR CAMERA (PAN-TILT) DRC-40KPT



PRODUCT FUNCTION

- Pan-Tilt camera (PT Connectable)
- 160° angle of view • Illuminance sensor
- Out door model • Surface-mounted type
- House call and talk • Built-in white LED

PRODUCT SPECIFICATION

Power source	12V(From monitor)
Operation Temp.	-40°C~+40°C
Wiring	4 wires
Camera angle adjusting	Ascendant : 15° Descendant : 12°
Distance	50m(0.65Ø)
Dimension(mm)	96(W)×155(H)×32(D)

MULTI BUTTON DOOR CAMERA (ONLY FOR FINE VIEW)

MULTI BUTTON DOOR CAMERA IS OPTIMIZED FOR SMALL SIZED APARTMENT COMPLEXES AND CAN BE COMBINED WITH COMMAX FINE VIEW SERIES.



MULTI BUTTON DOOR CAMERA DRC-2/4/6/8/10ML

NEW

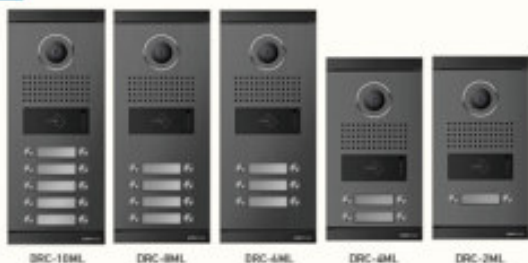

PRODUCT FUNCTION

- RF card registration and deletion possible
- 24 Direct buttons panel(DRC-24XM) expansibility
- 2/4/6/8/10 direct buttons
- OLED • Built-in white LED

PRODUCT SPECIFICATION

Power source	DC12V/1A
Operation Temp.	-20°C~+40°C
Wiring	4 wires
Camera view angle	Horizontal : 75° Vertical : 55°
Distance	28m(0.5Ø) 50m(0.65Ø)
Dimension(mm)	DRC-2(4)ML/RF1 : 130(W)×246(H)×50(D) DRC-6(8,10)ML/RF1 : 130(W)×315(H)×50(D)

MULTI BUTTON DOOR CAMERA DRC-24XM(F)



PRODUCT FUNCTION

- RF card registration and deletion possible
- 24 Direct buttons panel(DRC-24XM) expansibility
- 10 direct buttons
- OLED

PRODUCT SPECIFICATION

Power source	From DRC-6/8/10ML
Mount type	Flush-mounted type
Operating temp.	-20°C~+40°C
Dimension (mm)	130(W)×315(H)×10(D)

MULTI BUTTON DOOR CAMERA DRC-2UC



PRODUCT FUNCTION

- 2 button wide name plate
- Material : Aluminum
- House call and talk
- Built-in white LED • DC12V/1A

PRODUCT SPECIFICATION

Operation Temp.	-20°C~+50°C
Wiring	4 wires
Camera angle adjusting	Ascendant : 13° Descendant : 13°
Distance	28m(0.5Ø) 50m(0.65Ø)
Dimension(mm)	130(W)×250(H)×50(D)
Installation hole size(mm)	115(W)×223(H)
Fillupbox size(mm)	122(W)×239(H)×10(37)(D)

MULTI BUTTON DOOR CAMERA DRC-3UC



PRODUCT FUNCTION

- 3 button wide name plate
- Material : Aluminum
- House call and talk
- Built-in white LED • DC12V/1A

PRODUCT SPECIFICATION

Operation Temp.	-20°C~+50°C
Wiring	4 wires
Camera angle adjusting	Ascendant : 13° Descendant : 13°
Distance	28m(0.5Ø) 50m(0.65Ø)
Dimension(mm)	130(W)×250(H)×50(D)
Installation hole size(mm)	115(W)×223(H)
Fillupbox size(mm)	122(W)×239(H)×10(37)(D)

MULTI BUTTON DOOR CAMERA DRC-4UC



PRODUCT FUNCTION

- 4 button wide name plate
- Material : Aluminum
- House call and talk
- Built-in white LED • DC12V/1A

PRODUCT SPECIFICATION

Operation Temp.	-20°C~+50°C
Wiring	4 wires
Camera angle adjusting	Ascendant : 13° Descendant : 13°
Distance	28m(0.5Ø) 50m(0.65Ø)
Dimension(mm)	130(W)×250(H)×50(D)
Installation hole size(mm)	115(W)×223(H)
Fillupbox size(mm)	122(W)×239(H)×10(37)(D)

MULTI BUTTON DOOR CAMERA DRC-5UC



PRODUCT FUNCTION

- 5 button wide name plate
- Material : Aluminum
- House call and talk
- Built-in white LED • DC12V/1A

PRODUCT SPECIFICATION

Operation Temp.	-20°C~+50°C
Wiring	4 wires
Camera angle adjusting	Ascendant : 13° Descendant : 13°
Distance	28m(0.5Ø) 50m(0.65Ø)
Dimension(mm)	130(W)×315(H)×50(D)
Installation hole size(mm)	115(W)×289(H)
Fillupbox size(mm)	122(W)×305(H)×10(37)(D)

MULTI BUTTON DOOR CAMERA DRC-6UC



PRODUCT FUNCTION

- 6button wide name plate
- Material : Aluminum
- House call and talk
- Built-in white LED • DC12V/1A

PRODUCT SPECIFICATION

Operation Temp.	-20°C~+50°C
Wiring	4 wires
Camera angle adjusting	Ascendant : 13° Descendant : 13°
Distance	28m(0.5Ø) 50m(0.65Ø)
Dimension(mm)	130(W)×315(H)×50(D)
Installation hole size(mm)	115(W)×289(H)
Fillupbox size(mm)	122(W)×305(H)×10(37)(D)

MULTI BUTTON DOOR CAMERA DRC-7UC



PRODUCT FUNCTION

- 7 button wide name plate
- Material : Aluminum
- House call and talk
- Built-in white LED • DC12V/1A

PRODUCT SPECIFICATION

Operation Temp.	-20°C~+50°C
Wiring	4 wires
Camera angle adjusting	Ascendant : 13° Descendant : 13°
Distance	28m(0.5Ø) 50m(0.65Ø)
Dimension(mm)	130(W)×315(H)×50(D)
Installation hole size(mm)	115(W)×289(H)
Fillupbox size(mm)	122(W)×305(H)×10(37)(D)

MULTI BUTTON AUDIO UNIT

MULTI BUTTON AUDIO UNIT IS OPTIMIZED FOR SMALL AND MEDIUM SIZED APARTMENT COMPLEXES AND ENHANCES SECURITY WITH ACCESS CONTROL.



MULTI BUTTON AUDIO UNIT DR-2UM



PRODUCT FUNCTION

- 2 button wide name plate
- Material : Aluminum • LED light
- House call and talk • DC 12V

PRODUCT SPECIFICATION

DataTransmission	3 wire in common +1 wire
Communication	Hands-free type
Dimension(mm)	130(W)×315(H)×50(D)
Installation hole size(mm)	110(W)×284(H)
Fillupbox size(mm)	130(W)×315(H)×10(37)(D)

MULTI BUTTON AUDIO UNIT DR-4UM



PRODUCT FUNCTION

- 4 button wide name plate
- Material : Aluminum • LED light
- House call and talk • DC 12V

PRODUCT SPECIFICATION

DataTransmission	3 wire in common +1 wire
Communication	Hands-free type
Dimension(mm)	130(W)×315(H)×50(D)
Installation hole size(mm)	110(W)×284(H)
Fillupbox size(mm)	130(W)×315(H)×10(37)(D)

FIELD OF MULTI BUTTON AUDIO UNIT APPLICATION

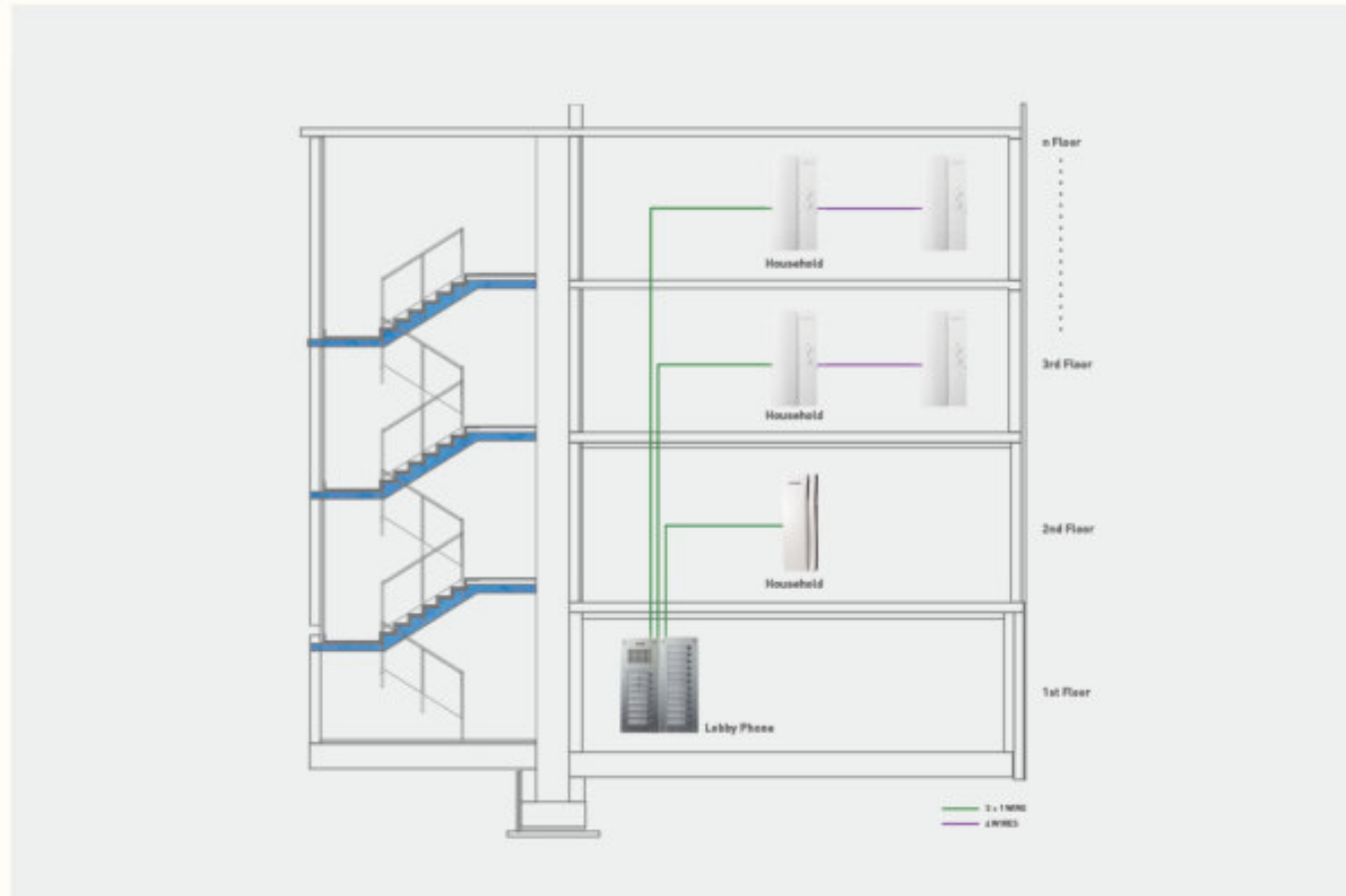

MULTI BUTTON AUDIO UNIT DR-6UM



PRODUCT FUNCTION

- 6 button wide name plate
- Material : Aluminum • LED light
- House call and talk • DC 12V

PRODUCT SPECIFICATION

DataTransmission	3 wire in common +1 wire
Communication	Hands-free type
Dimension(mm)	130(W)×315(H)×50(D)
Installation hole size(mm)	110(W)×284(H)
Fillupbox size(mm)	130(W)×315(H)×10(37)(D)

MULTI BUTTON AUDIO UNIT DR-8UM



PRODUCT FUNCTION

- 8 button wide name plate
- Material : Aluminum • LED light
- House call and talk • DC 12V

PRODUCT SPECIFICATION

DataTransmission	3 wire in common +1 wire
Communication	Hands-free type
Dimension(mm)	130(W)×315(H)×10(D)
Installation hole size(mm)	110(W)×284(H)
Fillupbox size(mm)	130(W)×315(H)×10(37)(D)

MULTI BUTTON AUDIO UNIT DR-nUS



PRODUCT FUNCTION

- Slave panel
- DR-4US/6US/8US/10US/12US
- Material : Aluminum • LED light
- House call and talk • DC 12V

PRODUCT SPECIFICATION

DataTransmission	3 wire in common +1 wire
Communication	Hands-free type
Dimension(mm)	130(W)×315(H)×10(D)
Installation hole size(mm)	110(W)×284(H)
Fillupbox size(mm)	130(W)×315(H)×10(37)(D)

*CONNECTABLE WITH DP-RS / DP-SS / DP-ML

DOORPHONE

DOORPHONE IS STANDARD PRODUCT LINE THAT PROVIDES A BETTER AUDIO QUALITY ALONG WITH ITS REFINED DESIGN.



DOORPHONE DP-RS

NEW



PRODUCT FUNCTION

- Door release
- Talk with a visitor
- User friendly handset design with convenient hand grip
- Link with Multi-Panel (DR-nUM)

PRODUCT SPECIFICATION

Power source	DC 12V(from Multipanel)
Mount type	Wall-mounted type (Bracket included)
Wiring	4 wires
Distance	Door unit : 100m (0.65Ø)
Dimension(mm)	58.3(W)×209(H)×48(D)

FIELD OF DOORPHONE APPLICATION

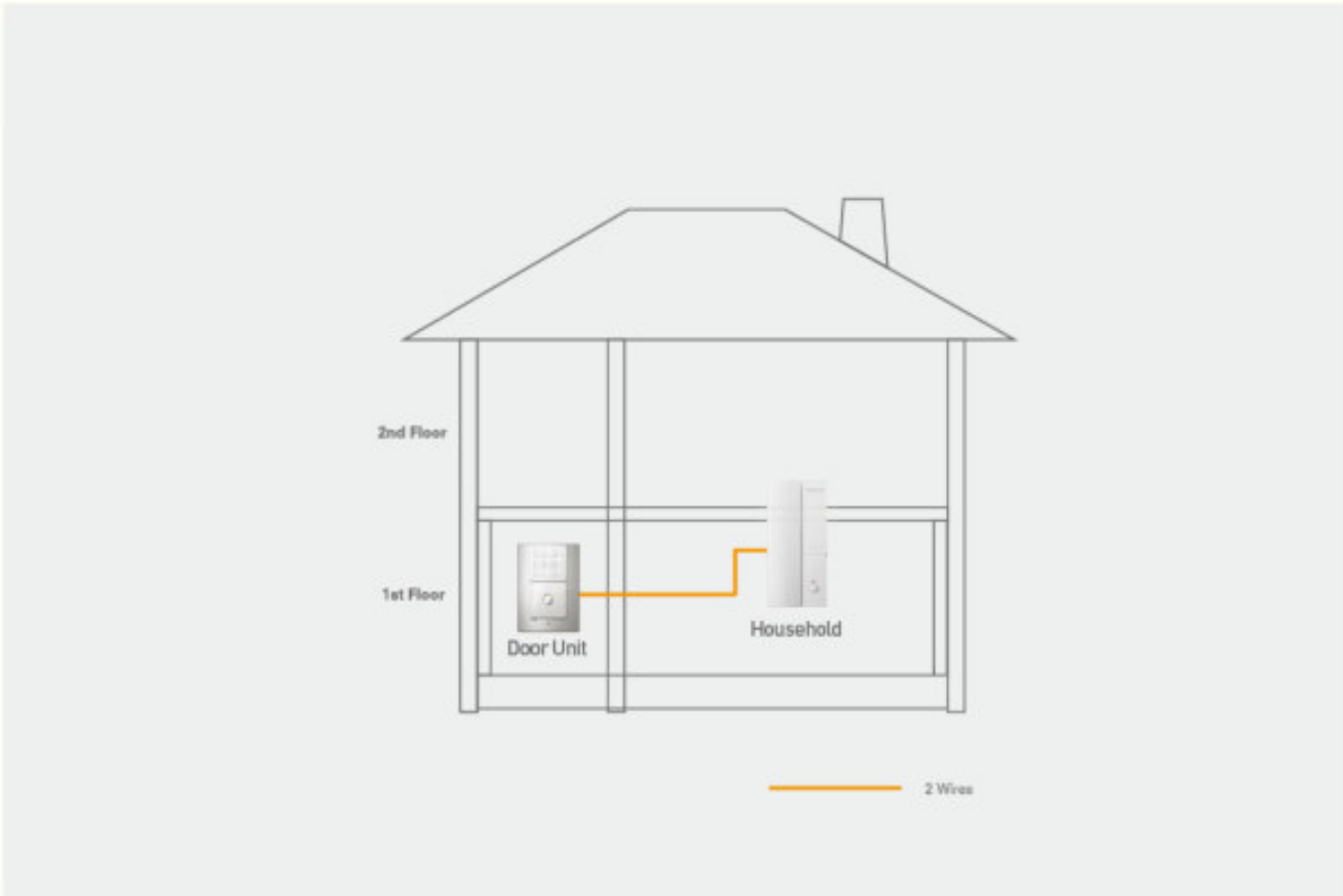

DOORPHONE DP-2LD



PRODUCT FUNCTION

- Battery operated(6V) or DC 9-12V Adaptor
- 2 wires with non-polarity
- Door release
- Talk with a visitor

PRODUCT SPECIFICATION

Power source	AA size 1.5V battery x 4, DC 9-12V Adaptor
Mount type	Wall-mounted type(Bracket included)
Wiring	Call : Non-polar 2 wires Door Release : 2 wires
Distance	Door unit : 100m (0.65Ø)
Dimension(mm)	98(W)× 208(H)×38(61)(D)
Battery life	15 months (stand-by) 9 months (use 15 times a day)

DOORPHONE DP-2S



PRODUCT FUNCTION

- 2 wires with non-polarity
- User friendly handset design with convenient hand grip
- Talk with a visitor
- Door release

PRODUCT SPECIFICATION

Power source	AC 110/220/230/240V 50/60Hz
Mount type	Wall-mounted type
Wiring	Call : 2 wires Door Release : 2 wires (1.6Ø Copper wire)
Distance	100m(0.65Ø), 150m(0.8Ø)
Dimension(mm)	108(W)×210(H)×33(61)(D)

DOORPHONE DP-LA101M/S



PRODUCT FUNCTION

- Talk with a visitor
- Door release
- 2 wires with non-polarity
- Power supply for doorlock release(12V)

PRODUCT SPECIFICATION

Power source	AC 220V, 50Hz only
Mount type	Wall-mounted type
Wiring	Call : 2 wires Door Release : 2 wires Master/Slave : 6 wires
Distance	50m Door to Room(0.65Ø) 30m Room to Room(0.65Ø)
Dimension(mm)	98(W)x208(H)x43(D)

DOORPHONE DP-201LA



PRODUCT FUNCTION

- Talk with a visitor • Door release
- 2 wires with non-polarity
- AC 12V Power enable with Door release button

PRODUCT SPECIFICATION

Power source	AC 220V, 50Hz only
Mount type	Wall-mounted type
Wiring	Call : 2 wires Door Release : 2 wires
Distance	100m(0.65Ø) 150m(0.8Ø)
Dimension(mm)	98(W)x208(H)x43(D)

DOORPHONE DP-LA01M/S



PRODUCT FUNCTION

- Talk with a visitor • Door release
- 2 wires with non-polarity
- User friendly handset design with convenient hand grip

PRODUCT SPECIFICATION

Power source	AC110/220/230/240V 50/60Hz
Mount type	Wall-mounted type
Wiring	Call : 2 wires Door Release : 2 wires Master/Slave : 5 wires
Distance	50m Door to Room 30m Room to Room
Dimension(mm)	98(W)x208(H)x43(D)

DOORPHONE DP-SS



PRODUCT FUNCTION

- Up to 40 house holds
- Talk with a visitor
- Door release

PRODUCT SPECIFICATION

Power source	DC 12V (Supplied by DR-nUM)
Mount type	Wall-mounted type
Wiring	DR-num : 4 wires Door release : 2 wires
Dimension(mm)	72(W)x210(H)x33(61)(D)

DOORPHONE DP-ML



PRODUCT FUNCTION

- Talk with a visitor
- Door release
- Up to 40 house holds
- Talk with a guard(DP-ML)

PRODUCT SPECIFICATION

Power source	AC 220V, 50Hz
Mount type	Wall-mounted type
Wiring	4 wires
Distance	100m(0.65Ø) 150m(0.8Ø)
Dimension(mm)	98(W)x208(H)x38(61)(D)

AUDIO DOOR UNIT DR-201D



PRODUCT FUNCTION

- House call and talk
- 2-wire entrance panel

PRODUCT SPECIFICATION

Power source	DC 9V (from Doorphone)
Mount type	Wall-mounted type
Operation temp.	-10°C~+40°C
Wiring	2 wires
Dimension(mm)	96(W)x140(H)x42(D)

AUDIO DOOR UNIT DR-2L



PRODUCT FUNCTION

- House call and talk
- 2-wire entrance panel

PRODUCT SPECIFICATION

Power source	DC 9V (from Doorphone)
Mount type	Wall-mounted type
Operation temp.	-10°C~+40°C
Wiring	2 wires
Dimension(mm)	126(W)x186(H)x23(D)

AUDIO DOOR UNIT DR-2K



PRODUCT FUNCTION

- House call and talk
- 2-wire entrance panel

PRODUCT SPECIFICATION

Power source	DC 9V(from Doorphone)
Mount type	Wall-mounted type
Operation temp.	-10°C~+40°C
Wiring	2 wires
Dimension(mm)	96(W)x128(H)x26(D)

AUDIO DOOR UNIT DR-2GN



PRODUCT FUNCTION

- Vandal proof
- House call and talk
- 2-wire entrance panel

PRODUCT SPECIFICATION

Power source	DC 9V(from Doorphone)
Mount type	Wall-mounted type
Operation temp.	-10°C~+40°C
Wiring	2 wires
Dimension(mm)	88(W)x120(H)x21(D)

AUDIO DOOR UNIT DR-2PN



PRODUCT FUNCTION

- Vandal proof
- House call and talk
- 2-wire entrance panel

PRODUCT SPECIFICATION

Power source	DC 9V(from Doorphone)
Mount type	Wall-mounted type
Operation temp.	-10°C~+40°C
Wiring	2 wires
Dimension(mm)	50(W)x118(H)x25(D)

INTERPHONE/ INTERCOM

THE QUINTESSENTIAL INTERPHONE AND INTERCOM WITH DISTINGUISHED DESIGN AND EXCELLENT QUALITY HAVE BEEN THE BEST SELLING COMMAX PRODUCTS FOR THE PAST 50 YEARS.



INTERPHONE TP-NR

NEW



PRODUCT FUNCTION

- User friendly handset design with convenient hand grip
- Link with TP-12RM

PRODUCT SPECIFICATION

Power source	DC 24V(from TP-12RM)
Mount type	Wall-mounted type
Wiring	2 wires
Distance	100m(0.65Ø), 150m(0.8Ø)
Dimension(mm)	58.3(W)×209(H)×48(D)

FIELD OF INTERPHONE/INTERCOM APPLICATION

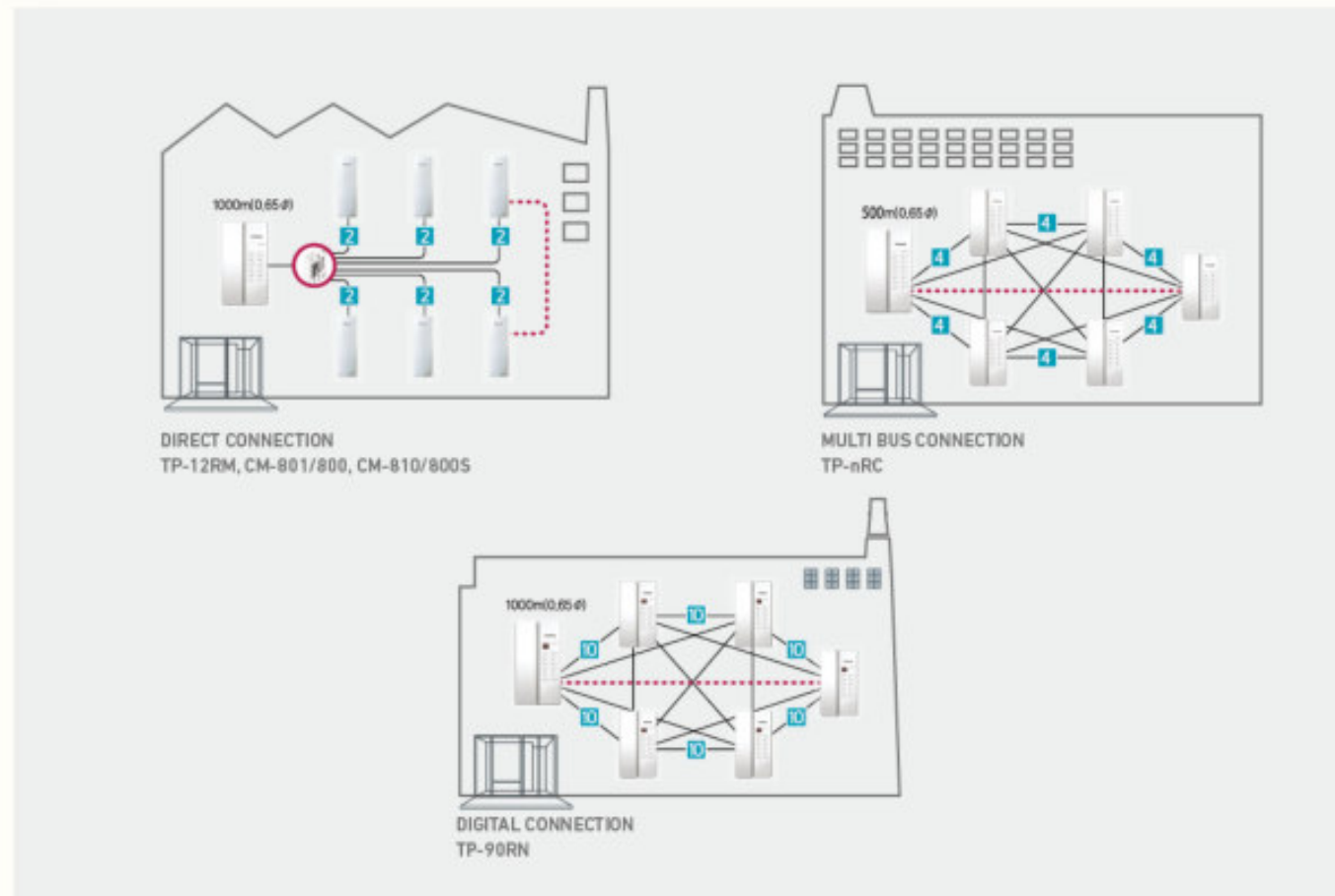

WIRELESS INTERPHONE WT-171L(M/S)



PRODUCT FUNCTION

- 1:1 Paging & Calling
- Auto frequency switching function to eliminate interference

PRODUCT SPECIFICATION

Power source	AC 100-240V, 50/60Hz
Mount type	Desk-top & Wall-mounted type
Wiring	Wireless
Distance	Open area : 250m (with barrier : 50m)
Frequency	1.7 GHz~1.9GHz
Dimension(mm)	98(W)×208(H)×43(66)(D)

WIRELESS INTERPHONE WDP-174L(M/S) WDR-174DS



PRODUCT FUNCTION

- 1:1 call with a door unit
- Talk with a visitor
- Door release via WDR-174DS (wireless door unit)

PRODUCT SPECIFICATION

Power source	WDP-174L : AC 100-240V, 50/60Hz WDR-174DS : DC 12V
Mount type	Desktop & Wall-mounted type
Wiring	Wireless
Distance	Open area : 250m (with barrier : 50m)
Frequency	1.7GHz~1.9GHz
Dimension(mm)	WDP-174L : 98(W)×208(H)×43(66)(D) WDR-174DS : 91(W)×134(H)×22(D)

INTERPHONE
TP-6RC



PRODUCT FUNCTION

- Variable system composition(6 units)
- ID setting enabled with dip switch
- Effective calling to all units by paging function
- Doorlock release • Calling & paging

PRODUCT SPECIFICATION

Power source	DC 12V, 200mA
Mount type	Wall-mounted type
Wiring	Common 4 wires
Distance	500m(0.65Ø)
Dimension(mm)	116(W)×208(H)×43(65)(D)

INTERPHONE
TP-12RC



PRODUCT FUNCTION

- Variable system composition(12 units)
- ID setting enabled with dip switch
- Effective calling to all units by paging function
- Doorlock release • Calling & paging

PRODUCT SPECIFICATION

Power source	DC 12V, 200mA
Mount type	Wall-mounted type
Wiring	Common 4 wires
Distance	500m(0.65Ø)
Dimension(mm)	116(W)×208(H)×43(65)(D)

INTERPHONE
TP-12RM



PRODUCT FUNCTION

- Supporting up to 12 pcs of TP-S, TP-NR(sub-unit)
- Covering total system just through one power installation
- Calling to each station • LED indication

PRODUCT SPECIFICATION

Power source	DC 24V, 170mA
Mount type	Wall-mounted type
Wiring	Invisible 2 wires
Distance	1Km(0.65Ø)
Dimension(mm)	116(W)×208(H)×43(65)(D)

INTERCOM
CM-801/800

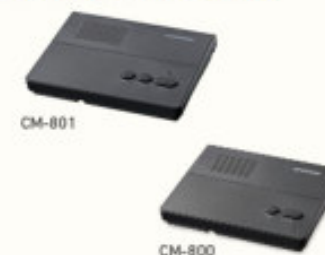

PRODUCT FUNCTION

- Enabling long distance communication through PTT function
- Calling to household
- Indicating in-use status

PRODUCT SPECIFICATION

Power source	DC 12V, 200mA
Consumption	Standby : 7mA Max : 160 mA
Operation temp.	0°C~+40°C
Wiring	2 wires
Distance	300m(0.65Ø)
Dimension(mm)	183(W)×169(H)×41(D)

INTERCOM
CM-810/800S



PRODUCT FUNCTION

- Calling ID display on the FND display with adjustable sound level
- Expendable up to 10 Units
- Enabling long distance communication through PTT

PRODUCT SPECIFICATION

Power source	DC 12V, 200mA
Consumption	Standby : 60mA Max : 370mA
Operation temp.	0°C~+40°C
Wiring	2 wires
Distance	300m(0.65Ø)
Dimension(mm)	183(W)×169(H)×41(D)

INTERCOM
CM-810M



PRODUCT FUNCTION

- Calling ID display on the FND display with adjustable sound level
- Expendable up to 10 Units
- Enabling long distance communication through PTT

PRODUCT SPECIFICATION

Power source	DC 12V, 1A
Consumption	Standby : 50mA Max : 100mA
Operation temp.	0°C~+40°C
Wiring	10 wires + n
Distance	200m(0.65Ø)
Dimension(mm)	183(W)×169(H)×41(D)

INTERPHONE
TP-90RN



PRODUCT FUNCTION

- Paging • Speaker phone • Caller ID display on FND display • 3 Channel simultaneous communication • Group call • Broadcasting • Privacy function • Expandable up to 90 pcs

PRODUCT SPECIFICATION

Power source	DC 24V, 120mA
Mount type	Wall-mounted type
Wiring	Common 10wires
Distance	1Km(0.65Ø)
Dimension(mm)	116(W)×208(H)×43(65)(D)

INTERPHONE
TP-1L



PRODUCT FUNCTION

- Recommended for hospital, guard station and office environment • 1:1 paging and talking feature • Convenient & Flexible installation by adopting 1.5 batteries

PRODUCT SPECIFICATION

Power source	AA size 1.5V battery 4ea
Mount type	Wall-mounted type
Wiring	Invisible 2 wires
Distance	100m(0.65Ø)
Dimension(mm)	98(W)×208(H)×42.7(D)

INTERPHONE
TP-S



PRODUCT FUNCTION

- User friendly handset design with convenient hand grip
- Link with TP-12RM

PRODUCT SPECIFICATION

Power source	DC 24V (form TP-12RM)
Mount type	Wall-mounted type
Wiring	Call : 2 wires
Distance	100m(0.65Ø) / 150m(0.8Ø)
Dimension(mm)	72(W)×215(H)×38(D)

WIRELESS INTERCOM
WI-3SN



PRODUCT FUNCTION

- No cross of wires
- Available to install anywhere with AC outlet
- Enabling long communication through PTT(priority call function)

PRODUCT SPECIFICATION

Power source	AC 100/120/220/230/ 240V, 50/60Hz
Wiring	Wireless
Dimension(mm)	186(W)×133(H)×44(D)

WIRELESS INTERCOM
WI-2B



PRODUCT FUNCTION

- No cross of wires
- Available to install anywhere with AC outlet
- Enabling long communication through PTT(priority call function)

PRODUCT SPECIFICATION

Power source	AC 100/120/220/230/ 240V, 50/60Hz
Wiring	Wireless
Dimension(mm)	143(W)×141(H)×47(D)

POWER INTERCOM
PI-30LN/20LN/10LN



PRODUCT FUNCTION

- System capacity: Max 30 • Group paging & whole paging and communicating • Receiving Lamp(flicker) • Control speaker volume and beep sound • Supporting up to 10,20,30pcs of CM-800L(sub-unit)

PRODUCT SPECIFICATION

Power source	AC 100/120/220/230/ 240V, 50/60Hz
Wiring	2 wires(STAR)
Distance	2Km(0.65Ø)
Dimension(mm)	313(W)×228(H)×98(D)

IP HOME SECURITY PLATFORM

INTEGRATION / CONNECTABLE INTELLIGENCE / ALL IP



IP CCTV

COMMAX PROVIDES VARIOUS IP CCTV SYSTEM BASED ON CUSTOMER'S NEEDS

- COST-EFFECTIVE CAMERA
- NIGHT SHOOTER CAMERA
- AI CAMERA - PTZ CAMERA
- STAND ALONE NVR
- PC BASED NVR - FREE CMS
- SMART VMS - MOBILE APP

FIELD OF IP CCTV APPLICATION

- Complex Apartment
- Building
- Shopping Mall
- Hotel
- Hospital
- Plant
- Smart City
- Border Defense
- Etc

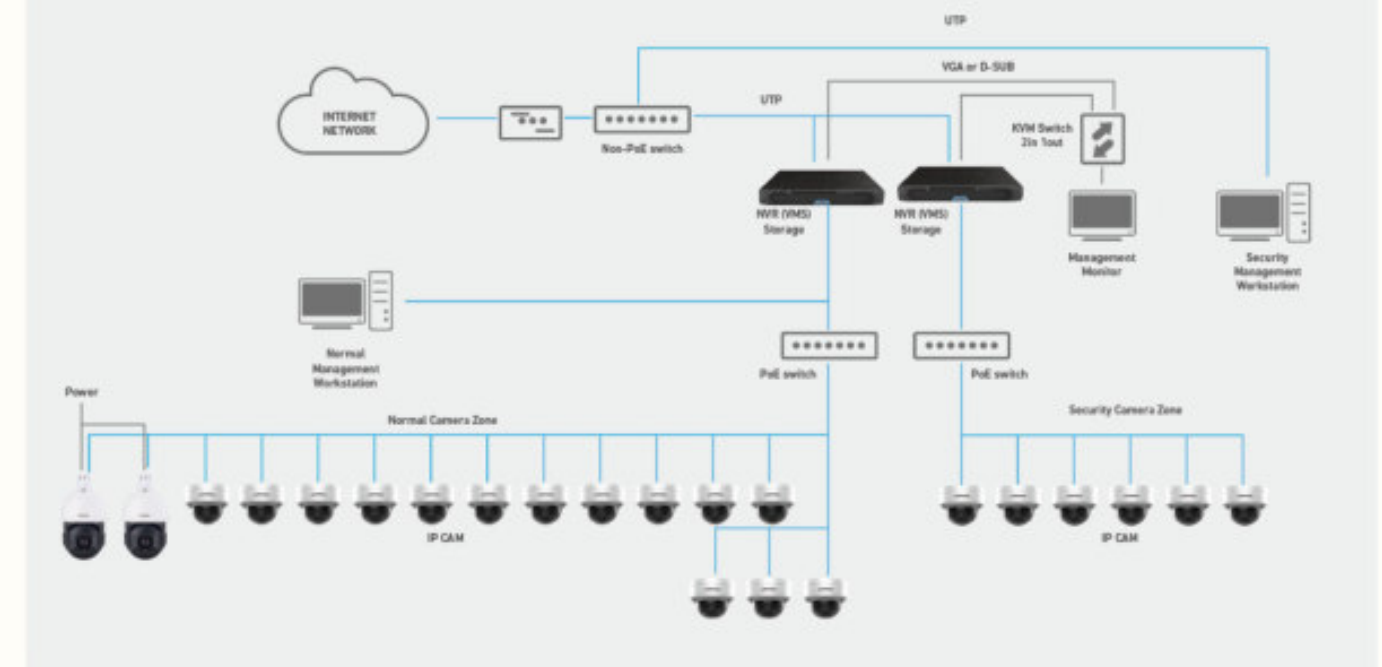

2MP NETWORK IR DOME CAMERA CNV-2M03R



PRODUCT FUNCTION

- 1 / 2.7" CMOS Progressive Scan Sensor • 2.8mm Fixed Lens
- 1920 x 1080@30fps • Multiple Streaming • Smart IR UP to 20m
- IP66 • WDR >120dB, 3D DNR

PRODUCT SPECIFICATION

Image Sensor	1 / 2.7" Progressive Scan CMOS
Min. Illumination	0.2Lux@(F1.2.AGC ON) 0Lux@(IR LED ON)
Lens	2.8mm
Video Compression	H.265 / H.264, MJPEG
Max. Image Resolution	1920x1080
Frame Rate	PAL : 1080p@25fps, 960p@25fps, 720p@25fps NTSC : 1080p@30fps, 960p@25fps, 720@30fps
System Compatibility	Onvif
On-board Storage	N/A
Operating Conditions	-20°C~50°C(-4°F~122°F) / Up to 90%RH / IP66
Power supply/Consump.	DC 12V ± POE / 2.5W(IR LED OFF) ; 5W (IR LED ON)
IR Range/LEDs	20m / 15pcs
Dimensions/Weight	110mm x 82mm / 800g

2MP NETWORK IR BULLET CAMERA CNU-2M04RN



PRODUCT FUNCTION

- 1 / 2.7" CMOS Progressive Scan Sensor • 3.6mm Fixed Lens
- 1920 x 1080@30fps • Multiple Streaming • Smart IR UP to 20m
- IP66 • WDR >120dB, 3D DNR

PRODUCT SPECIFICATION

Image Sensor	1 / 2.7" Progressive Scan CMOS
Min. Illumination	0.2Lux@(F1.2.AGC ON) 0Lux@(IR LED ON)
Lens	3.6mm
Video Compression	H.265 / H.264, MJPEG
Max. Image Resolution	1920x1080
Frame Rate	PAL : 1080p@25fps, 960p@25fps, 720p@25fps NTSC : 1080p@30fps, 960p@25fps, 720@30fps
System Compatibility	Onvif
On-board Storage	N/A
Operating Conditions	-20°C~50°C(-4°F~122°F) / Up to 90%RH / IP66
Power supply/Consump.	DC 12V ± POE / 2.5W(IR LED OFF) ; 5W (IR LED ON)
IR Range/LEDs	20m / 24pcs
Dimensions/Weight	194.35mm x 63mm / 631g

2MP NETWORK AUTO FOCUS IR DOME CAMERA CNV-2M4AR



PRODUCT FUNCTION

- 1 / 2.8" Sony CMOS Progressive Scan Sensor • 2.7 - 12mm Auto Focus Lens
- 1920 x 1080@60fps • Triple Streaming • Smart IR UP to 30m
- IP67 / IK10 • WDR >120dB, 3D DNR

PRODUCT SPECIFICATION

Image Sensor	1 / 2.8" Progressive Scan CMOS
Min. Illumination	0.001Lux@(F1.2.AGC ON) 0Lux@(IR LED ON)
Lens	2.7-12mm Auto Focus Lens
Video Compression	H.265 / H.264, MJPEG
Max. Image Resolution	1920x1080
Frame Rate	PAL : 1080p@50fps, 960p@50fps, 720p@50fps NTSC : 1080p@60fps, 960p@60fps, 720@60fps
System Compatibility	Onvif
On-board Storage	Micro SD/SDHC/SDXC slot, Max 128GB
Operating Conditions	-40°C~60°C(-40°F~140°F) / Up to 90%RH / IP67, IK10
Power supply/Consump.	DC 12V ± POE / 3W(IR LED OFF) ; 5W (IR LED ON)
IR Range/LEDs	30m / 15pcs
Dimensions/Weight	130mm x 112mm / 900g

2MP NETWORK AUTO FOCUS IR BULLET CAMERA CNU-2M4AR



PRODUCT FUNCTION

- 1 / 2.8" Sony CMOS Progressive Scan Sensor
- 2.7 - 12mm Auto Focus Lens • 1920 x 1080@60fps
- Triple Streaming • Smart IR UP to 30m • IP67 • WDR, 3D DNR

PRODUCT SPECIFICATION

Image Sensor	1 / 2.8" Progressive Scan CMOS
Min. Illumination	0.001Lux@(F1.2.AGC ON) 0Lux@(IR LED ON)
Lens	2.7-12mm Auto Focus Lens
Video Compression	H.265 / H.264, MJPEG
Max. Image Resolution	1920x1080
Frame Rate	PAL : 1080p@50fps, 960p@50fps, 720p@50fps NTSC : 1080p@60fps, 960p@60fps, 720@60fps
System Compatibility	Onvif
On-board Storage	Micro SD/SDHC/SDXC slot, Max 128GB
Operating Conditions	-40°C~60°C(-40°F~140°F) / Up to 90%RH / IP67
Power supply/Consump.	DC 12V ± POE / 5W(IR LED OFF) ; 8W (IR LED ON)
IR Range/LEDs	30m / 10pcs
Dimensions/Weight	80.3mm x 264.5mm / 830g

IP 4/8CH 1080P NVR CVN-0430FS/0830FS



PRODUCT FUNCTION

- Up to 4/8CH 1080P IP cameras access
- Easy to use Same Interface of GUI/WEB/Client
- 2 SATA hard disk up to 6TB • 4 / 8CH PoE Ports • Mini 1U

PRODUCT SPECIFICATION

Model		CVN-0430FS	CVN-0830FS
Input	IP Camera	4(24Mbps)	8(48Mbps)
	Resolution	6MP/5MP/4MP/3MP/1080P/960P /720P/D1/VGA/CIF/QCIF	
Private (IP Camera, Auto Connection)		4PoE	8PoE
Compression		H.264 (Baseline, Main, High Profile), M.JPEG	
Resolution & Frame Rate		120fps (D1/720p/1080p) / 240fps (D1/720p/1080p)	
HDD	Capacity of 1 HDD	6TB	
	Internal HDDs	2	
Power Source		DC 48V ~ DC 52V	AC110 / 220V
Operation Temperature		-10°C ~ 45°C	
Weight		2.8Kg	
Dimension		372mm x 311mm x 44.5mm	

2MP NETWORK SUPER STARLIGHT BOX CAMERA CNB-2MVX



PRODUCT FUNCTION

- 1 / 1.8" Sony STARVIS CMOS (Color 0.0008 Lux)
- 1920 x 1080@60fps • Triple Streaming • Auto Back Focus
- Dual IP • WDR (140dB) • Dual MicroSD Card • Defog

PRODUCT SPECIFICATION

Image Sensor	1 / 1.8" Sony STARVIS CMOS
Min. Illumination	0.0008Lux & 0.0001Lux@(F1.2. AGC ON)
Video Compression	S+265 / H.265 / H.264H / H.264M / H.264B / MJPEG
Max. Image Resolution	1920x1080
Frame Rate	PAL : 1080p@50fps, 960p@50fps, 720p@50fps NTSC : 1080p@60fps, 960p@60fps, 720@60fps
System Compatibility	Onvif (Profile S), SDK
On-board Storage	Dual Micro SD Card Slots, up to 512GB
Power supply/Consump.	DC 12V ± 10% / AC24V ± 10% / PoE / Max.6W
IR Range/LEDs	30m / 32pcs
Dimensions/Weight	58mm x 71mm x 145mm / 500g

IP 16CH 1080P NVR CVN-1630FS



PRODUCT FUNCTION

- Up to 16CH 1080P IP cameras access
- Easy to use Same Interface of GUI/WEB/Client
- 4 SATA hard disk up to 6TB • 16CH PoE Ports • Mini 1U

PRODUCT SPECIFICATION

Model		CVN-1630FS
Input	IP Camera	16(96Mbps)
	Resolution	6MP/5MP/4MP/3MP/1080P/960P /720P/D1/VGA/CIF/QCIF
Private (IP Camera, Auto Connection)		16PoE
Compression		H.264 (Baseline, Main, High Profile), M.JPEG
Resolution & Frame Rate		480fps (D1/720p/1080p)
HDD	Capacity of 1 HDD	6TB
	Internal HDDs	4
Power Source		AC110 / 220V
Operation Temperature		-10°C ~ 45°C
Weight		4Kg
Dimension		440mm x 376mm x 67mm

2MP NETWORK SUPER STARLIGHT IR BULLET CAMERA CNU-2M3ARX



PRODUCT FUNCTION

- 1 / 1.8" Sony STARVIS CMOS (Color 0.0008 Lux)
- 1920 x 1080@60fps • Triple Streaming • IR LED 54pcs (Max. 50m)
- IP67 • WDR (140dB) • Defog

PRODUCT SPECIFICATION

Image Sensor	1 / 1.8" Sony STARVIS CMOS
Min. Illumination	0.0008Lux & 0.0001Lux@(F1.2. AGC ON) 0Lux with IR
Lens	3.6-10mm Auto Focus Lens
Video Compression	H.265 / H.264 HP / MP / BP / M-JPEG
Max. Image Resolution	1920x1080
Frame Rate	PAL : 1080p@50fps, 960p@50fps, 720p@50fps NTSC : 1080p@60fps, 960p@60fps, 720@60fps
System Compatibility	Onvif (Profile S), SDK, CGI
Operating Conditions	-30°C~60°C(IR OFF) / -20°C~40°C(IR ON), 0 ~ 95% RHG
Power supply/Consump.	DC 12V ± 10%, PoE (802.3af) / Max. 2.7W(IR OFF) Max.7W(IR ON)
IR Range/LEDs	30-50m / 54pcs Ø 5 Array IR LEDs
Dimensions/Weight	107mm x 107mm x 337mm / 1.3Kg

2MP NETWORK SUPER STARLIGHT IR PTZ CAMERA CNP-2M30RL



PRODUCT FUNCTION

- 1 / 1.9" CMOS Progressive Scan Sensor • 1920 x 1080@30fps
- 2 Megapixel 30X Optical Zoom, 16X Digital Zoom • Multiple Streaming
- Smart IR Range 150m • IP66 • 3N DNR, dWDR, ICR • Reflection Optical Glass

PRODUCT SPECIFICATION

Image Sensor	1 / 1.9" Progressive Scan CMOS
Min. Illumination	0.0001Lux@(F1.2,AGC ON) 0Lux@(IR LED ON)
WDR	dWDR
Focal Length	6~180mm, 30X
Pan Speed	Manual 0.01°-180°/s, Preset 180°/s
Tilt Speed	Manual 0.01°-90°/s, Preset 90°/s
IR Irradiation Distance	150m
Max. Image Resolution	1920x1080@25/30fps
Image Compression	H.265 / H.264 High, Main, Baseline Profile / MJPEG
System Compatibility	Onvif
Power Supply	AC 24V, 2.5A / MAX 40W
Dimensions, Weight	205mm x 332mm / 4.3kg

3MP NETWORK IR PTZ CAMERA CNP-3M30R



PRODUCT FUNCTION

- 1 / 2.8" CMOS Progressive Scan Sensor • 2048 x 1536@30fps
- 3 Megapixel 30X Optical Zoom, 16X Digital Zoom • Multiple Streaming
- Smart IR Range 150m • IP66 • 3N DNR, dWDR, ICR • Reflection Optical Glass

PRODUCT SPECIFICATION

Image Sensor	1 / 2.8" Progressive Scan CMOS
Min. Illumination	0.01Lux@(F1.2,AGC ON) 0Lux@(IR LED ON)
WDR	dWDR
Focal Length	4.3~129mm, 30X
Pan Speed	Manual 0.01°-180°/s, Preset 180°/s
Tilt Speed	Manual 0.01°-90°/s, Preset 90°/s
IR Irradiation Distance	150m
Max. Image Resolution	2048x1536@25/30fps
Image Compression	H.265 / H.264 High, Main, Baseline Profile / MJPEG
System Compatibility	Onvif
Power Supply	AC 24V, 2.5A / MAX 40W
Dimensions, Weight	205mm x 332mm / 4.3kg

2MP NETWORK SUPER STARLIGHT IR PTZ CAMERA CNP-2M44RX



PRODUCT FUNCTION

- 1 / 1.8" Sony STARVIS CMOS (Color 0.0008 Lux)
- 2 Megapixel 44X Optical Zoom, 16X Digital Zoom • 1920 x 1080@60fps
- Triple Streaming • Smart IR (Max. 400m) • IP67 • WDR (140dB)

PRODUCT SPECIFICATION

Image Sensor	1 / 1.8" Sony STARVIS CMOS
Min. Illumination	Color 0.0008 Lux & Black& White 0.0002Lux @(F1.6,AGC ON), 0 Lux with IR
WDR	140dB
Focal Length	4.9-216mm, 44x
Pan Speed	Manual 0.1°-400°/s, Preset 240°/s stepless
Tilt Speed	Manual 0.1°-400°/s, Preset 240°/s
IR Irradiation Distance	400m
Max. Image Resolution	1920x1080@50/60fps
Image Compression	H.265/H.264, Encoding with Baseline/Main/High Profile
System Compatibility	ONVIF (Profile S), SDK
Power Supply	AC24V 3A
Dimensions, Weight	372mmx222mmx222mm, &15KG (with Packing Box)

4MP NETWORK IR DOME CAMERA CNV-4M03R



PRODUCT FUNCTION

- 1 / 1.3" CMOS Sensor • 2.8mm Fixed Lens
- 2592 x 1520@25fps • Triple Streaming • IR LED 8pcs (Max. 20m)
- IP67, IK10 • WDR (120dB) • Defog

PRODUCT SPECIFICATION

Image Sensor	1 / 1.3" CMOS Sensor
Min. Illumination	0.05Lux & 0.01Lux@(F1.2, AGC ON) 0Lux with IR Lens
Lens	2.8mm
Video Compression	S+265/H.265/S+264/H.264H/H.264M/H.264B/M-JPEG
Max. Image Resolution	2592 x 1520@25fps
Frame Rate	PAL : 1440p@25fps, 1080p@25fps, 960@25fps NTSC : 1440p@30fps, 1080p@30fps, 960@30fps
System Compatibility	Onvif(Profile S), SDK
On-board Storage	MicroSD Card Slot, up to 128GB
Operating Conditions	-35°C~60°C / Up to 95%RH / IP67, IK10
Power supply/Consump.	DC 12V ± 10%, PoE (802.3af)
IR Range/LEDs	20m / 8pcs
Dimensions/Weight	120mm x 120mm x 90mm / 700g

4MP NETWORK AUTO FOCUS IR DOME CAMERA CNV-4M4AR



PRODUCT FUNCTION

- 1 / 3" CMOS Sensor • 2.8 - 12mm Auto Focus Lens
- 2592 x 1520@25fps • Triple Streaming • IR LED 32pcs (Max. 30m)
- IP66, IK10 • WDR (120dB) • Defog

PRODUCT SPECIFICATION

Image Sensor	1 / 1.3" CMOS Sensor
Min. Illumination	0.05Lux & 0.01Lux@(F1.4, AGC ON) 0Lux with IR Lens
Lens	2.8 - 12mm Auto Focus Lens
Video Compression	S+265/H.265/S+264/H.264H/H.264M/H.264B/M-JPEG
Max. Image Resolution	2592 x 1520@25fps
Frame Rate	PAL : 1440p@25fps, 1080p@25fps, 960@25fps NTSC : 1440p@30fps, 1080p@30fps, 960@30fps
System Compatibility	Onvif(Profile S), SDK
On-board Storage	MicroSD Card Slot, up to 128GB / USB x 1
Operating Conditions	-35°C~60°C / Up to 95%RH / IP66, IK10
Power supply/Consump.	DC 12V ± 10%, PoE (802.3af)
IR Range/LEDs	30m / 32pcs
Dimensions/Weight	189mm x 70mm x 70mm / 1.0kg

4MP NETWORK AUTO FOCUS IR BULLET CAMERA CNU-4M4AR



PRODUCT FUNCTION

- 1 / 3" CMOS Sensor • 2.8 - 12mm Auto Focus Lens
- 2592 x 1520@25fps • Triple Streaming • IR LED 54pcs (Max. 50m)
- IP67 • WDR (120dB) • Defog

PRODUCT SPECIFICATION

Image Sensor	1 / 1.3" CMOS Sensor
Min. Illumination	0.05Lux & 0.01Lux@(F1.4, AGC ON) 0Lux with IR Lens
Lens	2.8 - 12mm Auto Focus Lens
Video Compression	S+265/H.265/S+264/H.264H/H.264M/H.264B/M-JPEG
Max. Image Resolution	2592 x 1520@25fps
Frame Rate	PAL : 1440p@25fps, 1080p@25fps, 960@25fps NTSC : 1440p@30fps, 1080p@30fps, 960@30fps
System Compatibility	Onvif(Profile S), SDK
On-board Storage	MicroSD Card Slot, up to 128GB / USB x 1
Operating Conditions	-35°C~60°C / Up to 95%RH / IP67
Power supply/Consump.	DC 12V ± 10%, PoE (802.3af)
IR Range/LEDs	50m / 54pcs
Dimensions/Weight	337mm x 107mm x 107mm / 1.3kg

4MP NETWORK IR BULLET CAMERA CNU-4M04R



PRODUCT FUNCTION

- 1 / 3" CMOS Sensor • 4 Megapixel 4mm Fixed Lens
- 2592 x 1520@25fps • Triple Streaming • IR LED 2pcs (Max. 25m)
- IP67 • WDR (120dB) • Defog

PRODUCT SPECIFICATION

Image Sensor	1 / 1.3" CMOS Sensor
Min. Illumination	0.05Lux & 0.01Lux@(F1.2, AGC ON) 0Lux with IR Lens
Lens	4mm Lens
Video Compression	S+265/H.265/S+264/H.264H/H.264M/H.264B/M-JPEG
Max. Image Resolution	2592 x 1520@25fps
Frame Rate	PAL : 1440p@25fps, 1080p@25fps, 960@25fps NTSC : 1440p@30fps, 1080p@30fps, 960@30fps
System Compatibility	Onvif(Profile S), SDK
On-board Storage	MicroSD Card Slot, up to 128GB
Operating Conditions	-35°C~60°C / Up to 95%RH / IP67
Power supply/Consump.	DC 12V ± 10%, PoE (802.3af)
IR Range/LEDs	25m / 2pcs Array
Dimensions/Weight	189mm x 70mm x 70mm / 700g

AHD CCTV

COMMAX'S SPECIALIZED ANALOG CCTV SYSTEM IS SUITABLE FOR CUSTOMER'S CONVENIENT EXPERIENCE IN SINGLE OR SMALL COMPLEX HOUSE.

- COST-EFFECTIVE CAMERA
- NIGHT SHOOTER CAMERA
- PTZ CAMERA
- ALL IN ONE STAND ALONE DVR
- STAND ALONE DVR INTERLOCKING WITH VIDEO DOOR PHONE
- FREE CMS - MOBILE APP

FIELD OF CCTV APPLICATION

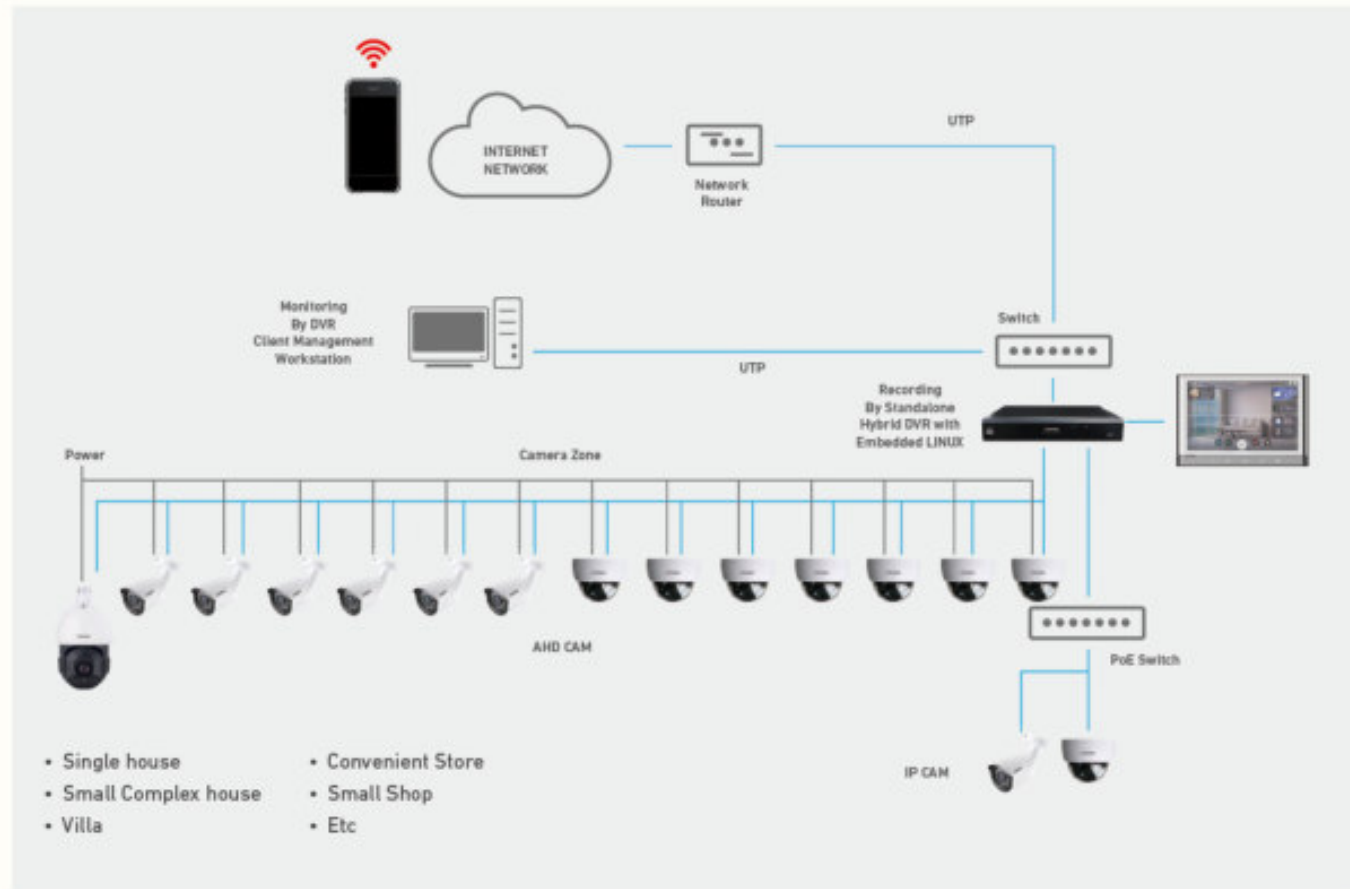

FHD INDOOR IR DOME CAMERA CAD-2M04R24S



PRODUCT FUNCTION

- 2Megapixel IR Dome Camera
- 1 / 3" Sony CMOS Image Sensor
- IR LED 24pcs
- 3.6mm Fixed Lens
- dWDR
- 2D/3D DNR
- UTC Supported

PRODUCT SPECIFICATION

Image Sensor	1 / 3" Sony CMOS Image Sensor
Min. Illumination	Color : 1.0 Lux, BW : 0.5 Lux Color DSS : 0.002 Lux, BW DSS : 0.0008 Lux
Lens	3.6mm Fixed
Max. Image Resolution	1080P MAX.
Backlight Compensation	Off / BLC / HSBLC
DNR	3D-DNR (Off / LoW / MIDDLE / HIGH)
Digital WDR	Auto / On / Off
Operating Conditions	-10°C-50°C / Up to 80%RH
Power supply/Consump.	DC 12V 1.5a / Max. 5W
IR Range/LEDs	15M (Ø5 x 24pcs)
Dimensions/Weight	93mm x 50mm / 170g

FHD INDOOR DOME CAMERA CAD-2M03S



PRODUCT FUNCTION

- 2Megapixel Dome Camera
- 1 / 3" Sony CMOS Image Sensor
- 2.8mm Fixed Lens
- dWDR
- 2D/3D DNR
- UTC Supported

PRODUCT SPECIFICATION

Image Sensor	1 / 3" Sony CMOS Image Sensor
Min. Illumination	Color : 1.0 Lux, BW : 0.5 Lux Color DSS : 0.002 Lux, BW DSS : 0.0008 Lux
Lens	2.8mm fixed
Max. Image Resolution	1080P MAX.
Backlight Compensation	Off / BLC / HSBLC
DNR	3D-DNR (Off / LoW / MIDDLE / HIGH)
Digital WDR	Auto / On / Off
Operating Conditions	-10°C-50°C / Up to 80%RH
Power supply/Consump.	DC 12V 1.5a / Max. 1W
IR Range/LEDs	N/A
Dimensions/Weight	113.8mm x 98mm / 250g

FHD INDOOR IR DOME CAMERA CAD-2M04R24SH



PRODUCT FUNCTION

- 2Megapixel IR Dome Camera
- 1 / 2.7" CMOS Image Sensor
- 3.6mm Fixed Lens
- dWDR
- 2D/3D DNR
- UTC Supported
- IR LED 24pcs

PRODUCT SPECIFICATION

Image Sensor	1/2.7" Aptina CMOS Sensor
Min. Illumination	Color : 3-5.5 Lux, BW : 0.8-2 Lux IR LED : 0.005Lux
Lens	3.6mm fixed
Max. Image Resolution	1080P MAX.
Backlight Compensation	Off / BLC / HSBLC
DNR	3D-DNR (Off / LoW / MIDDLE / HIGH)
Digital WDR	Auto / On / Off
Operating Conditions	-10°C-50°C / Up to 80%RH
Power supply/Consump.	DC 12V 1.5a / Max. 2.5W
IR Range/LEDs	20M (Ø5 x 24pcs)
Dimensions/Weight	93mm x 78mm / 350g

FHD IR BULLET CAMERA CAU-2M04R24SH



PRODUCT FUNCTION

- 2Megapixel IR Bullet Camera
- 1 / 2.7" CMOS Image Sensor
- 3.6mm Fixed Lens
- dWDR
- 2D/3D DNR
- UTC Supported
- IR LED 24pcs

PRODUCT SPECIFICATION

Image Sensor	1/2.7" Aptina CMOS Sensor
Min. Illumination	Color : 3-5.5 Lux, BW : 0.8-2 Lux IR LED : 0.005Lux
Lens	3.6mm fixed
Max. Image Resolution	1080P MAX.
Backlight Compensation	Off / BLC / HSBLC
DNR	3D-DNR (Off / LoW / MIDDLE / HIGH)
Digital WDR	Auto / On / Off
Operating Conditions	-10°C-50°C / Up to 80%RH
Power supply/Consump.	DC 12V 1.5a / Max. 3W
IR Range/LEDs	20M (Ø5 x 24pcs)
Dimensions/Weight	61mm x 64mm x 150mm / 500g

FHD IR BULLET CAMERA CAU-2M04R30S



PRODUCT FUNCTION

- 2Megapixel IR Bullet Camera
- 1 / 3" Sony CMOS Image Sensor
- 3.6mm Fixed Lens
- dWDR
- 2D/3D DNR
- UTC Supported
- IR LED 30pcs

PRODUCT SPECIFICATION

Image Sensor	1 / 3" Sony CMOS Image Sensor
Min. Illumination	Color : 1.0 Lux, BW : 0.5 Lux Color DSS : 0.002 Lux, BW DSS : 0.0008 Lux
Lens	3.6mm fixed
Max. Image Resolution	1080P MAX.
Backlight Compensation	Off / BLC / HSBLCL
DNR	3D-DNR (Off / LoW / MIDDLE / HIGH)
Digital WDR	Auto / On / Off
Operating Conditions	-10°C~50°C / Up to 80%RH
Power supply/Consump.	DC 12V 1.5A / Max. 4.2W
IR Range/LEDs	15M (Ø5 x 24pcs)
Dimensions/Weight	68mm x 70mm / 370g

FHD IR BULLET CAMERA CAU-2M04R6S



PRODUCT FUNCTION

- 2Megapixel IR Bullet Camera
- 1 / 3" Sony CMOS Image Sensor
- 3.6mm Fixed Lens
- dWDR
- 2D/3D DNR
- UTC Supported
- 6Array IR-LED

PRODUCT SPECIFICATION

Image Sensor	1 / 3" Sony CMOS Image Sensor
Min. Illumination	Color : 1.0 Lux, BW : 0.5 Lux Color DSS : 0.002 Lux, BW DSS : 0.0008 Lux
Lens	3.6mm fixed
Max. Image Resolution	1080P MAX.
Backlight Compensation	Off / BLC / HSBLCL
DNR	3D-DNR (Off / LoW / MIDDLE / HIGH)
Digital WDR	Auto / On / Off
Operating Conditions	-10°C~50°C / Up to 80%RH
Power supply/Consump.	DC 12V 1.5A / Max. 7W
IR Range/LEDs	25M (6 Array IR-LED)
Dimensions/Weight	88mm x 98mm x 261mm / 790g

FHD IR HOUSING CAMERA CAU-2M4VRH30SH



PRODUCT FUNCTION

- 2Megapixel IR Housing Camera
- 1 / 2.7" Aptina Image Sensor
- 2.8-12mm Varifocal Lens
- dWDR
- 2D/3D DNR
- UTC Supported
- IR LED 30pcs

PRODUCT SPECIFICATION

Image Sensor	1/2.7" Aptina CMOS Sensor
Min. Illumination	Color : 3-5.5 Lux, BW : 0.8-2 Lux IR LED : 0.005Lux
Lens	2.8-12mm Varifocal
Max. Image Resolution	1080P MAX.
Backlight Compensation	Off / BLC / HSBLCL
DNR	3D-DNR (Off / LoW / MIDDLE / HIGH)
Digital WDR	Auto / On / Off
Operating Conditions	-10°C~50°C / Up to 80%RH
Power supply/Consump.	DC 12V 1.5A / Max. 5.2W
IR Range/LEDs	40M (Ø8 x 30pcs)
Dimensions/Weight	138mm x 100mm x 330mm / 1Kg

FHD HYBRID STARLIGHT IR DOME CAMERA CAD-2M04R24HL



PRODUCT FUNCTION

- 2 Megapixel Analog Hybrid Starlight IR Dome Camera
- 1 / 2.8" Sony STARVIS CMOS Image Sensor
- 3.6mm Fixed Lens
- 30fps @ 1080p Full-HD
- IR LED 24pcs (Max. 15m)
- IP65

PRODUCT SPECIFICATION

Image Sensor	1 / 2.8" Sony STARVIS CMOS Image Sensor
Min. Illumination	0Lux (IR LED ON)
Lens	3.6mm Fixed
Max. Image Resolution	1080P MAX.
Backlight Compensation	Off / BLC / HSBLCL
DNR	3D-DNR (Off / LoW / MIDDLE / HIGH)
Digital WDR	Auto / On / Off
Operating Conditions	-30°C~40°C
Power supply/Consump.	DC 12V 1.5A / Max. 3.1W
IR Range/LEDs	15M (24pcs)
Dimensions/Weight	93mm x 75mm / 330g

FHD IR HOUSING CAMERA CAU-2M04RH36S



PRODUCT FUNCTION

- 2Megapixel IR Housing Camera
- 1 / 3" CMOS Image Sensor
- 3.6mm Fixed Lens
- dWDR
- 2D/3D DNR
- UTC Supported
- IR LED 36pcs

PRODUCT SPECIFICATION

Image Sensor	1 / 3" Sony CMOS Image Sensor
Min. Illumination	Color : 1.0 Lux, BW : 0.5 Lux Color DSS : 0.002 Lux, BW DSS : 0.0008 Lux
Lens	3.6mm fixed
Max. Image Resolution	1080P MAX.
Backlight Compensation	Off / BLC / HSBLCL
DNR	3D-DNR (Off / LoW / MIDDLE / HIGH)
Digital WDR	Auto / On / Off
Operating Conditions	-10°C~50°C / Up to 80%RH
Power supply/Consump.	DC 12V 1.5A / Max. 8W
IR Range/LEDs	20M (Ø8 x 36pcs)
Dimensions/Weight	150mm x 115mm x 305mm / 770g

FHD IR HOUSING CAMERA CAU-2M08RH30SH



PRODUCT FUNCTION

- 2Megapixel IR Housing Camera
- 1 / 2.7" Aptina Image Sensor
- 8.0mm Fixed Lens
- dWDR
- 2D/3D DNR
- UTC Supported
- IR LED 30pcs

PRODUCT SPECIFICATION

Image Sensor	1/2.7" Aptina CMOS Sensor
Min. Illumination	Color : 3-5.5 Lux, BW : 0.8-2 Lux IR LED : 0.005Lux
Lens	8.0mm fixed
Max. Image Resolution	1080P MAX.
Backlight Compensation	Off / BLC / HSBLCL
DNR	3D-DNR (Off / LoW / MIDDLE / HIGH)
Digital WDR	Auto / On / Off
Operating Conditions	-10°C~50°C / Up to 80%RH
Power supply/Consump.	DC 12V 1.5A / Max. 5.2W
IR Range/LEDs	40M (Ø8 x 30pcs)
Dimensions/Weight	138mm x 100mm x 330mm / 1Kg

FHD HYBRID STARLIGHT IR BULLET CAMERA CAU-2M04R36HL



PRODUCT FUNCTION

- 2 Megapixel Analog Hybrid Starlight IR Bullet Camera
- 1 / 2.8" Sony STARVIS CMOS Image Sensor
- 3.6mm Fixed Lens
- 30fps @ 1080p Full-HD
- IR LED 36pcs (Max. 18m)
- IP66

PRODUCT SPECIFICATION

Image Sensor	1 / 2.8" Sony STARVIS CMOS Image Sensor
Min. Illumination	0Lux (IR LED ON)
Lens	3.6mm Fixed
Max. Image Resolution	1080P MAX.
Backlight Compensation	Off / BLC / HSBLCL
DNR	3D-DNR (Off / LoW / MIDDLE / HIGH)
Digital WDR	Auto / On / Off
Operating Conditions	-30°C~40°C
Power supply/Consump.	DC 12V 1.5A / Max. 4.8W
IR Range/LEDs	18M (36pcs)
Dimensions/Weight	166.5mm x 83.8mm x 69.4mm / 480g

FHD HYBRID STARLIGHT IR BULLET CAMERA CAU-2M04R8HL



PRODUCT FUNCTION

- 2 Megapixel Analog Hybrid Starlight IR Bullet Camera
- 1 / 2.8" Sony STARVIS CMOS Image Sensor
- 3.6mm Fixed Lens
- 30fps @ 1080p Full-HD
- IR LED 8pcs (Max. 30m)
- IP66

PRODUCT SPECIFICATION

Image Sensor	1 / 2.8" Sony STARVIS CMOS Image Sensor
Min. Illumination	0Lux (IR LED ON)
Lens	3.6mm Fixed
Max. Image Resolution	1080P MAX.
Backlight Compensation	Off / BLC / HSBLCL
DNR	3D-DNR (Off / LoW / MIDDLE / HIGH)
Digital WDR	Auto / On / Off
Operating Conditions	-30°C~40°C
Power supply/Consump.	DC 12V 1.5A / Max. 6.6W
IR Range/LEDs	30M (Super High Power IR LED 8pcs)
Dimensions/Weight	231mm x 84mm x 110mm / 720g

FHD HYBRID STARLIGHT IR BULLET CAMERA CAU-2M4AR8HL



PRODUCT FUNCTION

- 2 Megapixel Analog Hybrid Starlight Auto Focus IR Bullet Camera
- 1 / 2.8" Sony STARVIS CMOS Image Sensor • IR LED 8pcs (Max. 30m)
- 2.8 - 12mm Auto Focus Lens • 30fps @ 1080p Full-HD • IP66

PRODUCT SPECIFICATION

Image Sensor	1 / 2.8" Sony STARVIS CMOS Image Sensor
Min. Illumination	0Lux (IR LED ON)
Lens	2.8 - 12mm Auto Focus
Max. Image Resolution	1080P MAX.
Backlight Compensation	Off / BLC / HSBC
DNR	3D-DNR (Off / LoW / MIDDLE / HIGH)
Digital WDR	Auto / On / Off
Operating Conditions	-30°C~40°C
Power supply/Consump.	DC 12V 1.5A / Max. 7.2W
IR Range/LEDs	30M (Super High Power IR LED 8pcs)
Dimensions/Weight	231mm x 84mm x 110mm / 720g

HYBRID DIGITAL VIDEO RECORDER CVD-AF16SH



PRODUCT FUNCTION

- 16ch AHD3.0 Hybrid DVR • Camera menu control via coaxial cable (UTC function)
- Supports diverse video standards AHD3.0/AHD2.0/AHD1.0/HD-TVI2.0/HD-CVI2.0/CVBS • Remote access through web browser, mobile and CDMS

PRODUCT SPECIFICATION

Model	CVD-AF16SH
Video Input	16BNC
Video Output	VGA & HDMI (1080p, 4K)
Video Compression	H.264
AHD 3.0 (2048x1536)	12fps/ch
AHD 2.0 (1920x1080)	15fps/ch
AHD 1.0 (1280x720)	30(25)fps/ch
HDD	2SATA HDD
Mobile	iPad / iPhone / Android
Web Viewer	Microsoft Internet Explorer, Firefox
PC Client Connection	CDMS
Power Supply	DC 12V, 5A
Operating Conditions	-10°C - 55°C, 10% - 90% RH (Non-condensing)
Dimensions/Weight	378mm x 53mm x 340mm / 4.5Kg

HYBRID DIGITAL VIDEO RECORDER CVD-AF04SH/AF08SH



PRODUCT FUNCTION

- 4ch/8ch AHD3.0 Hybrid DVR • Camera menu control via coaxial cable (UTC function)
- Supports diverse video standards AHD3.0/AHD2.0/AHD1.0/HD-TVI2.0/HD-CVI2.0/CVBS • Remote access through web browser, mobile and CDMS

PRODUCT SPECIFICATION

Model	CVD-AF04SH	CVD-AF08SH
Video Input	4BNC	8BNC
Video Output	VGA & HDMI (1080p)	
Video Compression	H.264	
AHD 3.0 (2048x1536)	9fps/ch	7fps/ch
AHD 2.0 (1920x1080)	15fps/ch	
AHD 1.0 (1280x720)	30(25)fps/ch	
HDD	1SATA HDD	
Mobile	iPad / iPhone / Android	
Web Viewer	Microsoft Internet Explorer, Firefox	
PC Client Connection	CDMS	
Power Supply	DC 12V, 2A	
Operating Conditions	-10°C - 55°C, 10% - 90% RH (Non-condensing)	
Dimensions/Weight	300mm x 53mm x 227mm / 3Kg	

GATEVIEW PLUS DIGITAL VIDEO RECORDER CVD-AF04SH PLUS



PRODUCT FUNCTION

- 4ch AHD3.0 / TVI3.0(TP2826) Hybrid DVR • CVBS for Commax Video Door Phone (Gateview+) • Camera menu control via coaxial cable (UTC function)
- Remote access through web browser, mobile and CDMS

PRODUCT SPECIFICATION

Model	CVD-AF04SH PLUS
Video Input	4BNC
Video Output	HDMI (1080p), VGA, CVBS
Video Compression	H.264
AHD 3.0 (2048x1536)	9 fps/ch
AHD 2.0 (1920x1080)	15fps/ch
AHD 1.0 (1280x720)	30(25)fps/ch
HDD	1SATA HDD Slot
Mobile	iPad / iPhone / Android
Web Viewer	Microsoft Internet Explorer, Firefox
PC Client Connection	CDMS
Power Supply	DC 12V, 2A
Operating Conditions	-10°C - 55°C, 10% - 90% RH (Non-condensing)
Dimensions/Weight	300mm x 53mm x 227mm / 3Kg

QHD IR DOME CAMERA CAD-4M04R24S



PRODUCT FUNCTION

- 4 Megapixel IR Dome Camera • 1 / 3" Omnivision CMOS Image Sensor (OV4689)
- 3.6 mm Fixed Lens • 4.0Megapixel @ 2688 x 1520

PRODUCT SPECIFICATION

Image Sensor	1 / 3" Omnivision CMOS Image Sensor
Min. Illumination	0.01Lux / F1.2, 0Lux IR on
Lens	3.6mm Fixed
Video Output	2560 x 1440
Backlight Compensation	Off / BLC / HSBC
DNR	2D-DNR (Off / LoW / MIDDLE / HIGH)
Digital WDR	Auto / On / Off
Operating Conditions	-20°C~60°C / Less than 90% RH
Power supply/Consump.	DC 12V 1.5A / Max. 2.9W
IR Range/LEDs	20M (Ø5 x 24pcs)
Dimensions/Weight	93mm x 76mm / 350g

QHD IR HOUSING CAMERA CAU-4M04RH30S



PRODUCT FUNCTION

- 4 Megapixel IR Housing Camera • 1 / 3" Omnivision CMOS Image Sensor (OV4689)
- 3.6 mm Fixed Lens • 4.0Megapixel @ 2688 x 1520

PRODUCT SPECIFICATION

Image Sensor	1 / 3" Omnivision CMOS Image Sensor
Min. Illumination	0.01Lux / F1.2, 0Lux IR on
Lens	3.6mm Fixed
Video Output	2560 x 1440
Backlight Compensation	Off / BLC / HSBC
DNR	2D-DNR (Off / LoW / MIDDLE / HIGH)
Digital WDR	Auto / On / Off
Operating Conditions	-20°C~60°C / Less than 90% RH
Power supply/Consump.	DC 12V 1.5A / Max. 4.2W
IR Range/LEDs	40M (Ø8 x 30pcs)
Dimensions/Weight	138mm x 100mm x 330mm / 1.27Kg

QHD IR BULLET CAMERA CAU-4M04R2S



PRODUCT FUNCTION

- 4 Megapixel IR Bullet Camera • 1 / 3" Omnivision CMOS Image Sensor (OV4689)
- 3.6 mm Fixed Lens • 4.0Megapixel @ 2688 x 1520

PRODUCT SPECIFICATION

Image Sensor	1 / 3" Omnivision CMOS Image Sensor
Min. Illumination	0.01Lux / F1.2, 0Lux IR on
Lens	3.6mm Fixed
Video Output	2560 x 1440
Backlight Compensation	Off / BLC / HSBC
DNR	2D-DNR (Off / LoW / MIDDLE / HIGH)
Digital WDR	Auto / On / Off
Operating Conditions	-20°C~60°C / Less than 90% RH
Power supply/Consump.	DC 12V 1.5A / Max. 3.5W
IR Range/LEDs	20M (2pcs Array IR Led)
Dimensions/Weight	65mm x 71mm x 182mm / 400g

5MP HYBRID IR DOME CAMERA CAD-5M04R30H



PRODUCT FUNCTION

- 5 Megapixel Analog Hybrid IR DOME Camera
- 1/2.7" Omnivision CMOS Image Sensor
- 4.0 mm Fixed Lens • 5.0Megapixel @ 2688 x 1944

PRODUCT SPECIFICATION

Image Sensor	1/2.7" Omnivision CMOS Image Sensor
Min. Illumination	0.01Lux / F2.0, 0Lux (IR on)
Lens	4.0mm Fixed
Max. Image Resolution	2688 x 1944, 5M pixels
Backlight Compensation	Off / BLC
DNR	2D,3D-DNR (Off / LoW / MIDDLE / HIGH)
Digital WDR	Auto / Off
Operating Conditions	-20°C~45°C
Power supply/Consump.	DC 12V 1.5A / Max. 3.6W
IR Range/LEDs	20M (30pcs)
Dimensions/Weight	127mm x 98mm / 270g

5MP HYBRID IR BULLET CAMERA
CAU-5M04R24H



PRODUCT FUNCTION

- 5 Megapixel Analog Hybrid IR Bullet Camera
- 1/2.7" Omnivision CMOS Image Sensor • IP66 / IK10
- 4.0 mm Fixed Lens • 5.0Megapixel @ 2688 x 1944

PRODUCT SPECIFICATION

Image Sensor	1/2.7" Omnivision CMOS Image Sensor
Min. Illumination	0.01Lux / F2.0, 0Lux (IR on)
Lens	4.0mm Fixed
Max. Image Resolution	2688 x 1944, 5M pixels
Backlight Compensation	Off / BLC
DNR	2D,3D-DNR (Off / LoW / MIDDLE / HIGH)
Digital WDR	Auto / Off
Operating Conditions	-20°C~45°C
Power supply/Consump.	DC 12V 1.5A / Max. 3W
IR Range/LEDs	15M (24pcs)
Dimensions/Weight	195mm x 70mm x 70mm / 300g

QHD HYBRID DIGITAL VIDEO RECORDER
CVD-AQ04SH/AQ08SH



PRODUCT FUNCTION

- 4ch/8ch AHD3.0 Hybrid DVR (IPC supported) • Supports diverse video standards AHD3.0/AHD2.0/AHD1.0/HD-TVI3.0/HD-CVI3.0/CVBS • Camera menu control via coaxial cable (UTC function) • Remote access through web browser, mobile and CDMS

PRODUCT SPECIFICATION

Model	CVD-AQ04SH	CVD-AQ08SH
Video Input	4BNC, 1IP	8BNC, 2IP
Video Output	VGA & HDMI (1080p)	VGA & HDMI (1080p, 4K)
Video Compression	H.264	
Analog 4MP (2592x1520)	15fps/ch (AHD Only)	
Analog 3MP (2048x1536)	20fps/ch	
Analog 1080P (1920x1080)	30(25) fps/ch	
IP 4MP (2592x1520)	17fps / ch	20fps / ch
IP 1080P (1920x1080)	30(25) fps / ch	
HDD	1 SATA HDD	
Power Supply	DC 12V , 2A	
Operating Conditions	-10°C ~ 55°C, 10% ~ 90% RH (Non-condensing)	
Dimensions/Weight	300mm x 53mm x 227mm / 3Kg	

5MP HYBRID IR BULLET CAMERA
CAU-5M04R36H



PRODUCT FUNCTION

- 5 Megapixel Analog Hybrid IR Bullet Camera
- 1/2.7" Omnivision CMOS Image Sensor • IP66 / IK10
- 4.0 mm Fixed Lens • 5.0Megapixel @ 2688 x 1944

PRODUCT SPECIFICATION

Image Sensor	1/2.7" Omnivision CMOS Image Sensor
Min. Illumination	0.01Lux / F2.0, 0Lux (IR on)
Lens	4.0mm Fixed
Max. Image Resolution	2688 x 1944, 5M pixels
Backlight Compensation	Off / BLC
DNR	2D,3D-DNR (Off / LoW / MIDDLE / HIGH)
Digital WDR	Auto / Off
Operating Conditions	-20°C~45°C
Power supply/Consump.	DC 12V 1.5A / Max. 3.6W
IR Range/LEDs	25M (36pcs)
Dimensions/Weight	261mm x 87mm x 75mm / 480g

QHD HYBRID DIGITAL VIDEO RECORDER
CVD-AQ16SH



PRODUCT FUNCTION

- 16ch AHD3.0 Hybrid DVR (IPC supported) • Supports diverse video standards AHD3.0/AHD2.0/AHD1.0/HD-TVI3.0/HD-CVI3.0/CVBS • Camera menu control via coaxial cable (UTC function) • Remote access through web browser, mobile and CDMS

PRODUCT SPECIFICATION

Model	CVD-AQ16SH
Video Input	16BNC, 4IP
Video Output	VGA & HDMI (1080p, 4K)
Video Compression	H.264
Analog 4MP (2592x1520)	15fps/ch (AHD Only)
Analog 3MP (2048x1536)	20fps/ch
Analog 1080P (1920x1080)	30(25) fps/ch
IP 4MP (2592x1520)	20fps / ch
IP 1080P (1920x1080)	30(25) fps / ch
HDD	2 SATA HDD
Power Supply	DC 12V , 5A
Operating Conditions	-10°C ~ 55°C, 10% ~ 90% RH (Non-condensing)
Dimensions/Weight	378mm x 50mm x 340mm / 4.5Kg

NURSE CALL SYSTEM

NURSE CALL SYSTEM PROVIDES AN "ONE-STOP" COMMUNICATION SOLUTION FOR INTELLIGENT HOSPITAL SYSTEM.



BED HEAD CONSOLE
JNS-3000



PRODUCT FUNCTION

- Paging and calling nurse's waiting room
- Various ways of emergency paging and calling
- Multi-device featured console (AC outlet, light, TV holder, name card)

PRODUCT SPECIFICATION

Power source	From JNS-PSM
Mount type	Flush-mounted type
Wiring	4 wires
Distance	100m(0.65Ø)
Dimension(mm)	833(W)×196(H)×81(D)

BED HEAD CONSOLE
JNS-1000



PRODUCT FUNCTION

- Paging and calling nurse's waiting room
- Various ways of emergency paging and calling
- Multi-device featured console (AC outlet, light)

PRODUCT SPECIFICATION

Power source	From JNS-PSM
Mount type	Flush-mounted type
Wiring	4 wires
Distance	100m(0.65Ø)
Dimension(mm)	530(W)×117(H)×16(78)(D)

BED HEAD CONSOLE(4 WIRES)
JNS-4CS



PRODUCT FUNCTION

- Paging and calling nurse's waiting room
- Various ways of emergency paging and calling
- Interlocking with corridor lights (CL-302I and others)

PRODUCT SPECIFICATION

Power source	From JNS-PSM
Mount type	Flush-mounted type
Wiring	4 wires
Distance	100m(0.65Ø)
Dimension(mm)	195(W)×117(H)×16(D)

SOFTWARE
MANAGEMENT PROGRAM



PRODUCT FUNCTION

- Software: Google, Fire Fox, iOS, IE
- Connectivity : JNS-70MN
- Available Microsoft office Excel

OPERATING ROOM STATION
JNS-360



PRODUCT FUNCTION

- LED status indication
- Hands-set
- Volume control enabled
- Channel select function
- Group announcement function
- Desktop

PRODUCT SPECIFICATION

Power source	AC 220, 60Hz
Mount type	Desktop
Wiring	Common 2 wires + separate 12 wires including power
Distance	600m(0.65Ø)
Dimension(mm)	360(W)×232(H)×105(D)

OPERATING ROOM CALL SYSTEM
JNS-6KO



PRODUCT FUNCTION

- A simple name tag
- LED status indication
- Flush-mounted type
- Hands-free function

PRODUCT SPECIFICATION

Power source	From JNS-360
Mount type	Flush-mounted type
Wiring	6 wires
Distance	100m
Dimension(mm)	305(W)×117(H)×16(D)

MAIN NURSE STATION(4 WIRES)
JNS-70MN



PRODUCT FUNCTION

- A simple memo function
- Hands-free function
- Group announcement function.
- Installation flexibility (Desktop/Surface-mounted type)

PRODUCT SPECIFICATION

Power source	From JNS-PSM
Mount type	Wall-mounted type
Wiring	4 wires
Distance	100m(0.65Ø)
Dimension(mm)	252(W)×247(H)×40(D)

NURSE STATION
JNS-4CM



PRODUCT FUNCTION

- Paging and calling nurse's waiting room
- Various ways of emergency paging and calling
- Interlocking with corridor lights (CL-302I and others)

PRODUCT SPECIFICATION

Power source	From JNS-PSM
Mount type	Desktop
Wiring	4 wires
Distance	100m(0.65Ø)
Dimension(mm)	327(W)×230(H)×97(D)

MAIN PANEL
JNS-PSM



PRODUCT FUNCTION

- Power supply and signal relay
- Automatic UPS connection in case of a blackout

PRODUCT SPECIFICATION

Power source	AC 220- 240V, 60Hz
Mount type	Wall-mounted type
Wiring	Common 4 wires 2 wires separate
Distance	100m(0.65Ø)
Dimension(mm)	420(W)×328(H)×105(D)

OPERATING ROOM FOOT SWITCH
FS-600



PRODUCT FUNCTION

- Foot switch in operating room
- LED status indication

PRODUCT SPECIFICATION

Power source	From JNS-360
Mount type	Flush-mounted type
Wiring	6 wires
Distance	10m
Dimension(mm)	573(W)×117(H)×16(66)(D)

OPERATING ROOM STATION
JNS-36



PRODUCT FUNCTION

- LED status indication
- Hands-set
- Volume control enabled
- Channel select function
- Desktop

PRODUCT SPECIFICATION

Power source	AC 220, 60Hz
Mount type	Desktop
Wiring	Common 2 wires + separate 12 wires including power
Distance	600m(0.65Ø)
Dimension(mm)	360(W)×232(H)×105(D)

OPERATING ROOM ARM SWITCH
AS-100



PRODUCT FUNCTION

- Arm switch
- Operation room
- Hands-free intercom
- Flush-mounted type

PRODUCT SPECIFICATION

Power source	From JNS-36
Mount type	Flush-mounted type
Wiring	3 wires
Distance	100m
Dimension(mm)	195(W)×117(H)×16(66)(D)

MAIN NURSE STATION(8 WIRES)
CNS-70MN



PRODUCT FUNCTION

- A simple memo function.
- Group announcement function.
- Hands-free function.
- Installation flexibility (Desktop/Surface-mounted type)

PRODUCT SPECIFICATION

Power source	From CNS-PSM
Mount type	Desktop(Wall-mounted type)
Wiring	8 wires
Distance	100m(0.65Ø)
Dimension(mm)	252(W)×247(H)×40(D)

BED HEAD CONSOLE(8 WIRES)
CNS-4CS



PRODUCT FUNCTION

- Paging and calling nurse's waiting room
- Various ways of emergency paging and calling
- Interlocking with corridor lights (CL-302I and others)

PRODUCT SPECIFICATION

Power source	From CNS-PSM
Mount type	Flush-mounted type
Wiring	8 wires
Distance	100m(0.65Ø)
Dimension(mm)	195(W)×117(H)×16(D)

MAIN PANEL
CNS-PSM



PRODUCT FUNCTION

- Power supply and signal relay
- Automatic UPS connection in case of a blackout

PRODUCT SPECIFICATION

Power source	AC 220- 240V, 60Hz
Mount type	Wall-mounted type
Wiring	Common 4 wires 2 wires separate
Distance	100m(0.65Ø)
Dimension(mm)	420(W)×328(H)×105(D)

EM. SWITCH
ES-400



PRODUCT FUNCTION

- Emergency switch (restroom)
- Waterproof

PRODUCT SPECIFICATION

Power source	From JNS-4CS/CNS-8CS
Mount type	Flush-mounted type
Wiring	2 wire
Distance	71(W)×116(H)×3(45)(D)
Dimension(mm)	420(W)×328(H)×105(D)

SHOWER EM. SWITCH
ES-420



PRODUCT FUNCTION

- Emergency switch (Shower room)
- Waterproof

PRODUCT SPECIFICATION

Power source	From JNS-4CS
Mount type	Flush-mounted type
Wiring	2 wires
Dimension(mm)	118(W)×118(H)×3(45)(D)

PRESENCE SWITCH
PB-500



PRODUCT FUNCTION

- Presence switch

PRODUCT SPECIFICATION

Power source	From JNS-4CS/CNS-8CS
Mount type	Flush-mounted type
Wiring	2 wires
Dimension(mm)	71(W)×116(H)×3(45)(D)

NURSE CALL SWITCH
CNS-8CD



PRODUCT FUNCTION

- Able to call and talk to a nurse as well as call cancel function
- Interlocking with Corridor light, CNS-70MN and emergency switch

PRODUCT SPECIFICATION

Power source	DC 29V (from CNS-PSM)
Mount type	Desktop type
Wiring	Common 8 wires 2 wires separate
Distance	100m(0.65Ø)
Dimension(mm)	183(W)×169(H)×41(D)

OPERATING ROOM ARM SWITCH
(8 WIRES)
CNS-8AS



PRODUCT FUNCTION

- Call by elbow switch
- When calling, flashing red LED, ringing melody
- Cancel button
- Interlocking with FOOT switch
- Able to communicate with CNS-70MN

PRODUCT SPECIFICATION

Power source	DC 29V (from CNS-PSM)
Mount type	Flush-mounted type
Wiring	8 wires
Distance	100m(0.65Ø)
Dimension(mm)	195(W)×117(H)×16(D)

NURSE STATION DISTRIBUTOR
CNS-812LD/812MD



PRODUCT FUNCTION

- Connection to the slave phone in a hospital room from master phone and sub nursing phone
- Connection function of display panel
- Able to connect up to 4 Sub-groups
- Signal distribution for simultaneous calling

PRODUCT SPECIFICATION

Power source	DC 24V
Mount type	Wall-mounted type
Wiring	Common 8 wires 2 wires separate
Distance	100m(0.65Ø)
Dimension(mm)	106(W)×76(H)×44(D)

CALL CORD SW.
CC-200



PRODUCT FUNCTION

- Emergency call cord

PRODUCT SPECIFICATION

Power source	From JNS-4CS
Mount type	Fixing clip on the bed
Wiring	2 wires

PILLOW SPEAKER
PS-100



PRODUCT FUNCTION

- Pillow speaker
- Remote control of On/Off(2 lamps)

PRODUCT SPECIFICATION

Power source	From JNS-4CS/CNS-8CS
Mount type	Fixing clip on the bed
Wiring	8 wires
Dimension(mm)	55(W)×171(H)×20(D)

CORRIDOR LIGHT
CL-302I



PRODUCT FUNCTION

- Corridor light
- 2 Colors mode(Red/Green)
- LED

PRODUCT SPECIFICATION

Power source	From JNS-4CS/CNS-8CS
Mount type	Flush-mounted type
Wiring	8 wires(lamp 1, 2, 3, 4)
Dimension(mm)	118(W)×118(H)×73.1(D)

SMART DOORLOCK

SMART DOORLOCK IS AN ACCESS CONTROL SYSTEM WITH PROVEN SAFETY, USABILITY AND LEADING DESIGN FOR YOUR HOME SECURITY.



ROCK AND LOCK CDL-800WL

NEW



PRODUCT FUNCTION

- 2 WAY ACCESS methods (Pin number, Finger)
- Durable body using metallic material for protecting against high temp. and shock
- High Temp. detection, alert and automatic unlocking
- Multi-Layered authentication (Pin number, Finger)
- Automatic lock / Re-lock / Double lock functions
- Anti high-voltage / Anti-hacking system
- Emergency power (9V square battery+Micro USB 5pin)

PRODUCT SPECIFICATION

Applicable	Normal fire door	Thickness 35mm ~ 50mm
Access methods	Pin number	4-12 digit number combination (Up to 4 pin number)
	Finger	Up to 100 Fingers
Power source	DC 6V	Alkaline AA battery, 4pcs(LR6 1.5V AA size)
Emergency	DC 9V	Alkaline battery (Optional) Micro USB 5pin
Type of product	Anti-fireproof type, Temperature sensor type	
Temperature alarm	Temperature sensor	60 degree ± 5 degree(Normal test)
Option	Remote module(CDL-800WLC)	
Dimension(mm)	Outer body : 387(H)×82(W)×69(D)	

ROCK AND LOCK CDL-100WL

NEW



PRODUCT FUNCTION

- 2 WAY ACCESS methods (RF Card, Pin number)
- Durable body using metallic material for protecting against high temp. and shock
- High Temp. detection, alert and automatic unlocking
- Multi-Layered authentication (RF Card, Pin number)
- Automatic lock / Re-lock / Double lock functions
- Safe to use the pin number with dummy number
- Anti high-voltage / Anti-hacking system
- Emergency power (9V square battery+Micro USB 5pin)

PRODUCT SPECIFICATION

Applicable	Normal fire door	Thickness 35mm ~ 50mm
Access methods	Pin number	4-12 digit number combination (Up to 4 pin number)
	RF card	Up to 30 cards
Power source	DC 6V	Alkaline AA battery, 4pcs(LR6 1.5V AA size)
Emergency	DC 9V	Alkaline battery (Optional) Micro USB 5pin
Type of product	Anti-fireproof type, Temperature sensor type	
Temperature alarm	Temperature sensor	60 degree ± 5 degree(Normal test)
Option	Remote module(CDL-100WLC)	
Dimension(mm)	387(H)×82(W)×69(D)	

SMART DOORLOCK CDL-220PB

NEW



PRODUCT FUNCTION

- 4 WAY ACCESS methods (RF Card, Pin number, Mechanical Key, BLE)
- Durable body using metallic material for protecting against high temp. and shock
- High Temp. detection, alert and automatic unlocking
- Multi-Layered authentication (Pin number/RF Card/Finger)
- Automatic lock / Re-lock / Double lock functions
- Safe to use the pin number with dummy number
- Anti high-voltage / Fireproof / Anti-hacking system
- Connectivity with home network system using remote controller (Option)
- Emergency power (9V square battery)

PRODUCT SPECIFICATION

Applicable	Normal fire door	Thickness 40mm ~ 60mm
Access methods	Pin number	4-12 digit number combination (Up to 4 pin number)
	RF card	Up to 30 cards
	BLE	Smart phone
	Mechanical Key	Individual mechanical lock
Power source	DC 6V	Alkaline AA battery, 8pcs(LR6 1.5V AA size)
Type of product	Fireproof type, Temperature sensor type, Key type, Master key doorlock	
Temperature alarm	Temperature sensor	60 degree ± 5 degree
Option	Remote module(CDL-447)	
Dimension(mm)	Outer body : 95.0(W)x28.8(D)x95.0(H) Inner body : 81.3(W)x36.2(D)x163.5(H)	

SMART DOORLOCK CDL-200P



PRODUCT FUNCTION

- 3 WAY ACCESS methods (RF Card, Pin number, Mechanical Key)
- Durable body using metallic material for protecting against high temp. and shock
- High Temp. detection, alert and automatic unlocking
- Multi-Layered authentication (Pin number/RF Card)
- Automatic lock / Re-lock / Double lock functions
- Safe to use the pin number with dummy number
- Anti high-voltage / Fireproof / Anti-hacking system
- Connectivity with home network system using remote controller (Option)
- Emergency power (9V square battery)

SMART DOORLOCK CDL-210L



PRODUCT FUNCTION

- 4 WAY ACCESS methods (RF Card, Pin number, Mechanical Key, Finger)
- Durable body using metallic material for protecting against high temp. and shock
- High Temp. detection, alert and automatic unlocking
- Multi-Layered authentication (Pin number/RF Card/Finger)
- Automatic lock / Re-lock / Double lock functions
- Safe to use the pin number with dummy number
- Anti high-voltage / Fireproof / Anti-hacking system
- Connectivity with home network system using remote controller (Option)
- Emergency power (9V square battery)

SMART DOORLOCK CDL-210P



PRODUCT FUNCTION

- 4 WAY ACCESS methods (RF Card, Pin number, Finger, Mechanical Key)
- Durable body using metallic material for protecting against high temp. and shock
- High Temp. detection, alert and automatic unlocking
- Multi-Layered authentication (Pin number/RF Card/Finger)
- Automatic lock / Re-lock / Double lock functions
- Safe to use the pin number with dummy number
- Anti high-voltage / Fireproof / Anti-hacking system
- Connectivity with home network system using remote controller (Option)
- Emergency power (9V square battery)

PRODUCT SPECIFICATION

Applicable	Normal fire door	Thickness 40mm ~ 60mm
Access methods	Pin number	4-12 digit number combination (Up to 4 pin number)
	RF card	Up to 30 cards
	Mechanical Key	Individual mechanical lock
Power source	DC 6V	Alkaline AA battery, 8pcs(LR6 1.5V AA size)
Type of product	Fireproof type, Temperature sensor type, Key type, Master key doorlock	
Temperature alarm	Temperature sensor	60 degree ± 5 degree
Option	Remote module(CDL-447)	
Dimension(mm)	Outer body : 95.0(W)x28.8(D)x95.0(H) Inner body : 81.3(W)x36.2(D)x163.5(H)	

SMART DOORLOCK CDL-200L



PRODUCT FUNCTION

- 3 WAY ACCESS methods (RF Card, Pin number, Mechanical Key)
- Durable body using metallic material for protecting against high temp. and shock
- High Temp. detection, alert and automatic unlocking
- Multi-Layered authentication (Pin number/RF Card)
- Automatic lock / Re-lock / Double lock functions
- Safe to use the pin number with dummy number
- Anti high-voltage / Fireproof / Anti-hacking system
- Connectivity with home network system using remote controller (Option)
- Emergency power (9V square battery)

SMART DOORLOCK ADT-100DL/REMOTE CONTROL

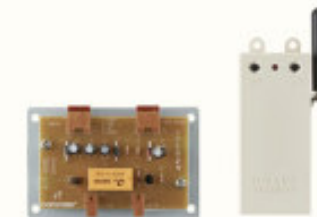

PRODUCT FUNCTION

- Input the individual door release signal

PRODUCT SPECIFICATION

Power source	Power supply from monitor Monitor to ADT-100DL : DC 12V ADT-100DL to remote control : DC 9V
Wiring	Camera to ADT-100DL : 4wires ADT-100DL to remote control : 2wires
Mount type	Attached Type
Dimension(mm)	80(W)x52(H)x20(D)

SMART DOORLOCK
CDL-410M

NEW



PRODUCT FUNCTION

- 2 WAY ACCESS methods (RF Card, Pin number)
- Durable body using metallic material
- Automatic lock / Re-lock / Double lock functions
- Safe to use the pin number with dummy number
- Multi-registrations for pin-number & electronic key
- Multiple volume control / optional mute
- Emergency power (9V square battery)
- Anti high-voltage / Anti-hacking system
- Home networking of remote controller (CDL-410MC)
- Edge Design

PRODUCT SPECIFICATION

Applicable	Normal fire door	Thickness 40mm - 60mm
Access methods	Pin number	4-12 digit number combination (Up to 4 pin number)
	RF card	Up to 30 keys
	Emergency key	Can be used under out of battery
Power source	DC 6V	Alkaline AA battery, 4pcs(LR6 1.5V AA size)
Emergency	DC 9V	Alkaline battery (Optional)
Wireless devices For safe system (CDL-410MC)		447.275Mhz
Type of product	Anti-fireproof type, Temperature sensor type, Key type, Mini Master key doorlock	
Temperature alarm	Temperature sensor	60 degree ± 5 degree (Normal test)
Dimension(mm)	80(W)x230(H)x26(D)	

SMART DOORLOCK
CDL-300L

NEW



PRODUCT FUNCTION

- 3 WAY ACCESS methods (RF Card, Pin number, Mechanical Key)
- Durable body using metallic material for protecting against high temp. and shock
- High Temp. detection, alert and automatic unlocking
- Multi-Layered authentication (Pin number/RF Card)
- Automatic lock / Re-lock / Double lock functions
- Safe to use the pin number with dummy number
- Anti high-voltage / Fireproof / Anti-hacking system
- Connectivity with home network system using remote controller (Option)
- Emergency power (5V Mirco USB)

PRODUCT SPECIFICATION

Applicable	Normal fire door	Thickness 40mm - 60mm
Access methods	Pin number	4-12 digit number combination (Up to 4 pin number)
	RF card	Up to 30 cards
	Emergency key	Can be used under out of battery
Power source	DC 6V	Alkaline AA battery, 8pcs(LR6 1.5V AA size)
Emergency	DC 5V	Micro USB 5pin
Wireless devices For safe system		Option
Type of product	Fireproof type, Temperature sensor type, Key type, Master key doorlock	
Temperature alarm	Temperature sensor	60 degree ± 5 degree (Normal test)
Dimension(mm)	78(W)x360(H)x81(D)	

SMART DOORLOCK
CDL-400M

NEW



PRODUCT FUNCTION

- 2 WAY ACCESS methods (RF Card, Pin number)
- Durable body using metallic material
- Automatic lock / Re-lock / Double lock functions
- Safe to use pin number with dummy number
- Multi-registrations for pin-number & electronic key
- Multiple volume control / optional mute
- Emergency power (9V square battery)
- Anti high-voltage / Anti-hacking system
- Home networking of remote controller (CDL-400MC)

PRODUCT SPECIFICATION

Applicable	Normal fire door	Thickness 40mm - 60mm
Access methods	Pin number	4-12 digit number combination (Up to 4 pin number)
	RF card	Up to 30 keys
	Emergency key	Can be used under out of battery
Power source	DC 6V	Alkaline AA battery, 4pcs(LR6 1.5V AA size)
Emergency	DC 9V	Alkaline battery (Optional)
Wireless devices For safe system (CDL-400MC)		447.275Mhz
Type of product	Anti-fireproof type, Temperature sensor type, Key type, Mini Master key doorlock	
Temperature alarm	Temperature sensor	60 degree ± 5 degree (Normal test)
Dimension(mm)	80(W)x230(H)x26(D)	

SMART DOORLOCK
CDL-811P/811R



PRODUCT FUNCTION

- 4 WAY ACCESS methods (RF Card, Pin number, Finger, Mechanical Key)
- Durable body using metallic material for protecting against high temp. and shock
- High Temp. detection, alert and automatic unlocking
- Multi-Layered authentication (Pin number/RF Card/Finger)
- Automatic lock / Re-lock / Double lock functions
- Safe to use the pin number with dummy number
- Anti high-voltage / Anti-hacking system
- Connectivity with home network system using remote controller (Option)
- Emergency power (9V square battery)
- Pull-Push Option (CDL-811R)

PRODUCT SPECIFICATION

Applicable	Normal fire door	Thickness 60mm - 120mm
Access methods	Pin number	4-12 digit number combination (Up to 4 pin number)
	RF card	Up to 30 cards
	Emergency key	Can be used under out of battery
Power source	DC 6V	Alkaline AA battery, 8pcs(LR6 1.5V AA size)
Emergency	DC 9V	Alkaline battery (Optional)
Wireless devices For safe system (CDL-410MC)		447.275Mhz
Type of product	Anti-fireproof type, Temperature sensor type, Key type, Mini Master key doorlock	
Temperature alarm	Temperature sensor	60 degree ± 5 degree (Normal test)
Dimension(mm)	78(W)x410(H)x81(D)	

TIPS FOR AN ENHANCED
EXPERIENCE

GUIDE TO USING THIS COMPREHENSIVE CATALOG

COMMAX AR APP DOWNLOAD

Scan the printed QR code and Download
COMMAX AR APP



ANDROID



iOS

MOBILE APPLICATION AR CODE READER



1. Please Launch the Commax AR App



2. Cut an AR code sheet out of this book
(Appendix section)



3. Stick the AR code sheet on the wall or
any interior surface. Scan the code with the
COMMAX mobile application. Enjoy COMMAX AR
product contents from your mobile device.

GUIDE TO USING THIS COMPREHENSIVE CATALOG | TIPS FOR AN ENHANCED EXPERIENCE

Using any QR code reader,
you can explore not only product information,
but also enjoy different video clips,
360 degree images, and even try AR applications.

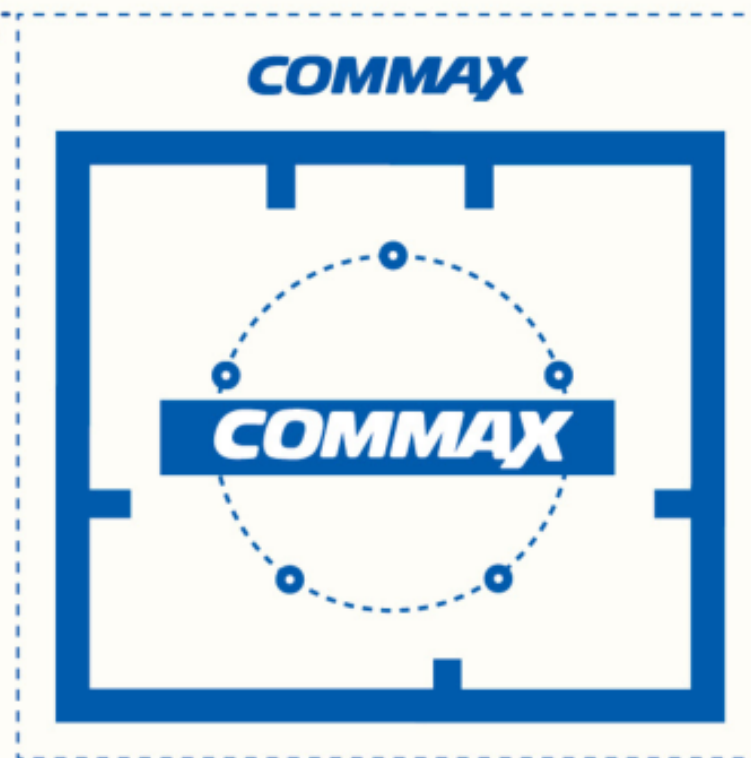
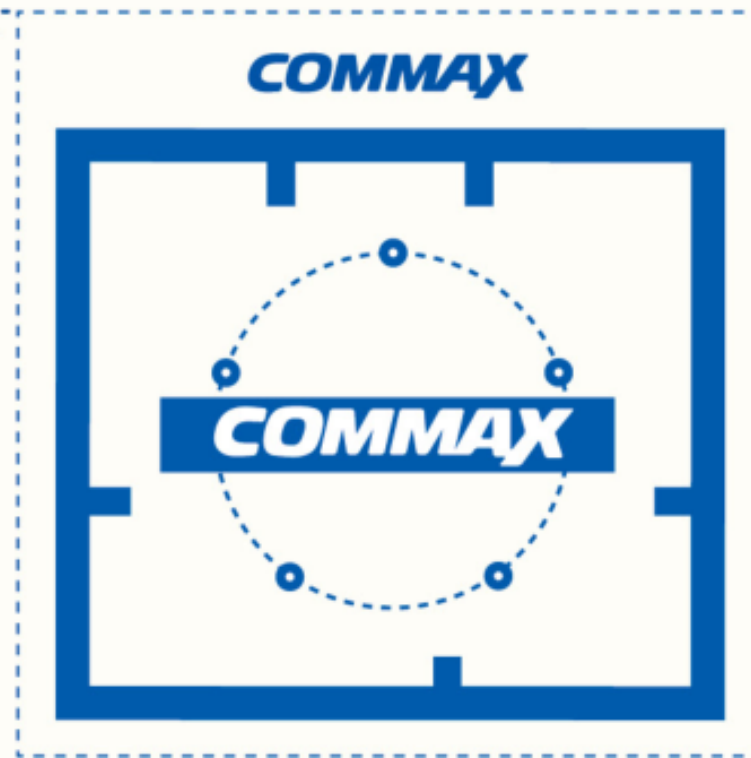

COMMAX

COMMAX Co.Ltd.

#13229, 494, Dunchon-daero, Jungwon-gu,
Seongnam-si, Gyeonggi-do, Korea
TEL. +82-31-7393-540-550 / FAX. +82-31-745-2133

www.commax.com
www.facebook.com/commax.global
www.youtube.com/commaxvideo

