

# COLOR VIDEO DOOR PHONE

Model No. CDV-71BQ/ 71BQS

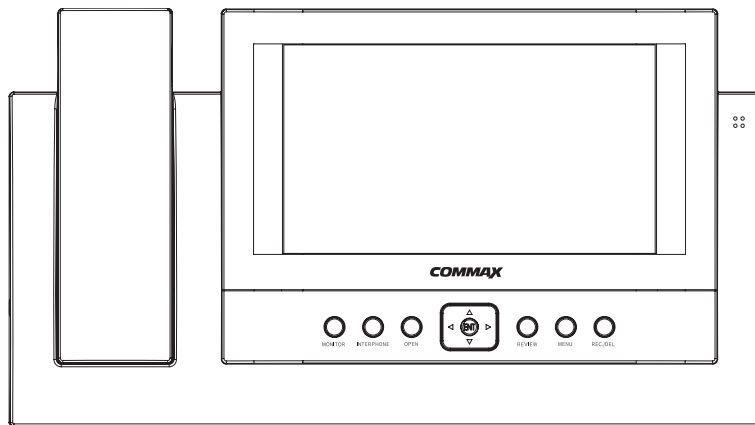

## COMMAX Co.,Ltd.

- Thank you for purchasing our COMMAX product.
- Please carefully read this User's Guide (in particular, precautions for safety) before using the product and follow the instructions to use your product exactly.
- The company is not responsible for any safety accidents caused in abnormal operation of the product.

# Table of Contents

<b>Warnings and caution</b> .....	<b>2</b>
<b>The Function and Name of Each Part</b> .....	<b>4</b>
<b>Features and Main Functions</b> .....	<b>5</b>
<b>Package contents</b> .....	<b>6</b>
<b>System Layout</b> .....	<b>6</b>
<b>Wiring Diagram</b> .....	<b>7</b>
<b>Installation Method</b> .....	<b>8</b>
<b>Operating Description</b> .....	<b>9</b>
<b>Menu Setting for CDV-71BQ</b> .....	<b>10</b>
<b>Picture Memory</b> .....	<b>12</b>
<b>Review</b> .....	<b>13</b>
<b>Screen Adjustment</b> .....	<b>14</b>
<b>Trouble shooting</b> .....	<b>15</b>
<b>Specification</b> .....	<b>16</b>

# Warnings and caution

○ Make sure to follow the instructions to prevent any danger or property losses.



**Warning** Death or serious injury is expected.

- It indicates prohibition.
- It indicates prohibition of disassembly.
- It indicates prohibition of contact.
- It indicates dos and don'ts.
- It indicates that the plug should be pulled out from the socket.



**Warning**

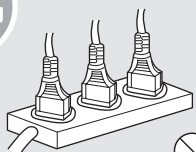

**Do not put the plug in the socket simultaneously.**  
It may generate abnormal heat or cause a fire.

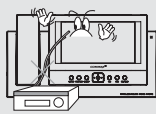

**Do not connect to other products while in use.**  
It may cause breakdown.



**Do not forcibly bend the cord or put a heavy object on the product.**  
It may cause a fire.

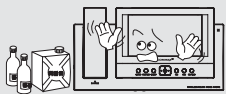

**Do not use water, thinner or a detergent used to wash oil products when you wash the exterior.**  
Make sure to wash it by using a dry cloth to prevent any breakdown or electric shock.



**Do not install the product in a humid place.**  
It may cause an electric shock or a fire.

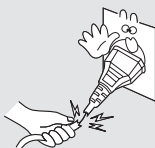

**Do not forcibly pull out the cord from the socket.**  
If the cord is damaged, it may cause a fire or an electric shock.

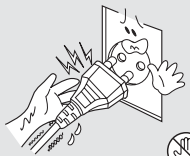

**Do not put the plug in the socket with a wet hand.**  
It may cause an electric shock.

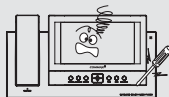

**Do not disassemble, repair or modify the product.**  
It may cause a fire, an electric shock or an injury due to malfunction of the product.

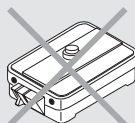

**Do not use AC circuit breaker.**  
It may cause an electric shock.

# Warnings and caution



**Caution** An injury or property losses are expected

- It indicates prohibition.
- It indicates prohibition of disassembly.
- It indicates prohibition of contact.
- It indicates dos and don'ts.
- It indicates that the plug should be pulled out from the socket.



**Caution**

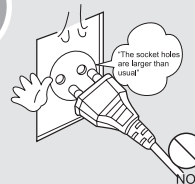

**If the socket holes are larger than normal, do not put the plug.**  
It may cause an electric shock or a fire.

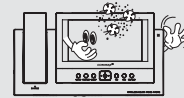

**Make sure that dust or foreign substances are not gathered on the product.**



**Make sure to prevent foreign substances from entering the product.**  
It may cause a breakdown.



**Do not put a heavy object on the product.**  
It may cause a breakdown.

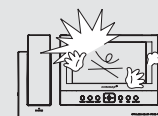

**Do not disassemble or give an impact to the product.**

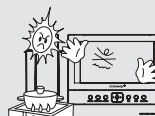

**Avoid direct rays of the sun or heating devices at a time of installation.**

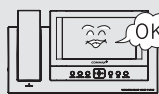

**Install the product in a flat and stable place.**  
Otherwise, it may not function properly.



**Pull the plug if the product is not used for a long time.**

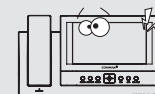

**If the product generates strange sound, make sure to pull the plug immediately and contact Commax service center.**

# 1. The Function and Name of Each Part

► function

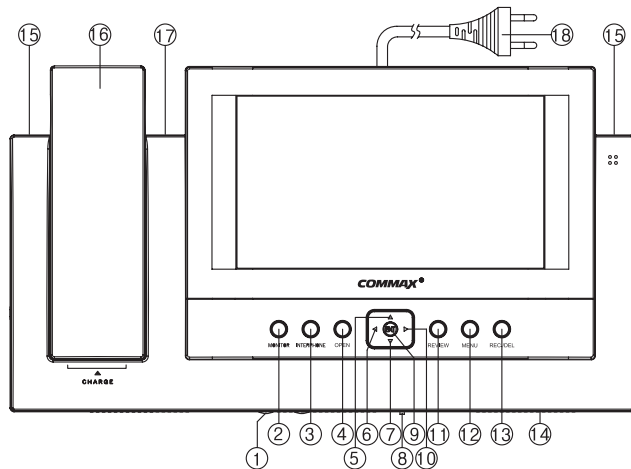

No.	Name	Details
1	Volume control	Control the call volume
2	Monitor button	View screen by door camera or talk
3	Interphone button	Talk by interphone between the rooms
4	Open button	Operate on Door release of door camera
5	Up button	Up direction key
6	Left button	Left direction key
7	Down button	Down direction button
8	Power switch	Control the power supply of product
9	Enter button	Execution button
10	Right button	Right direction key

# 2. Features and main Function

## 1. Features

- 7" Wide TFT-LCD
- Surface mount type installation method
- Free voltage power source
- OSD ( On screen Display)

## 2. Main function

- Communicate between Front door camera and CDV-71BQ
- Sub-monitors(CDV-71BQS) call and talk function
- Image storing NTSC : 68cuts with quad  
PAL : 58 cuts with quad by either manual and auto mode.
- Door Open function
- CCTV Camera available
- 4 Door camera units (Inter-connectable with door cameras or CCTV cameras) & 2 sub-monitors connectable
- Quad screen function

No.	Name	Details
11	REVIEW	Review the stored pictures in memory
12	Menu	Set the Function of the CDV-71BQ/S
13	REC./DEL.	Delete the recorded visitors images.
14	Speaker	Audio speaker
15	Mood lamp	Creates pleasant light display at night
16	Handset	Handset
17	Auto recording status Lamp	On away mode, it displays to set "Recording visitor's pictures by Auto"
18	Power source code	Supply power source of product (AC100V-240V Free-voltage)

### Note: CDV-71BQS

18	Pre/Menu	It allows to move to previous recorded image and to change each item on the Menu.
13	Next button	It allows to move to next recorded image.

### 3. Package Contents

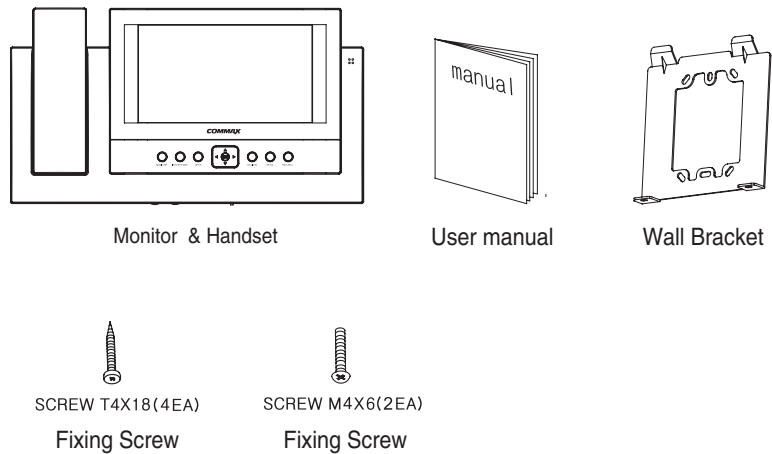

### 4. System Layout

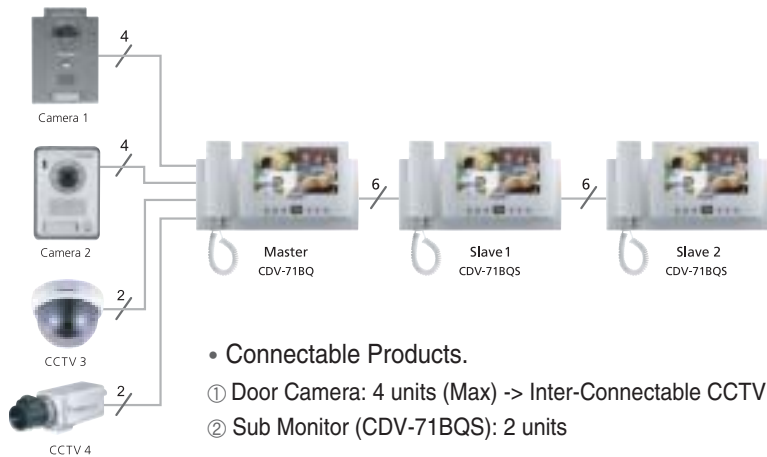

• Connectable Products.

- ① Door Camera: 4 units (Max) -> Inter-Connectable CCTV Camera
- ② Sub Monitor (CDV-71BQS): 2 units

• Wiring

- ① Camera : 30M(at  $\varnothing 0.5\text{mm}$ ) / 50M(at  $\varnothing 0.65\text{mm}$ ) / 70M(at  $\varnothing 0.8\text{mm}$ )
- ② Sub Video Phone : 30M(at  $\varnothing 0.65\text{mm}$ ) / 50M(at  $\varnothing 0.8\text{mm}$ )
- ③ Main distributor to CCTV Camera : Coaxial Cable

### 5. Wiring Diagram

- Please carefully connect wiring terminal on polarity
- Communication line between master and slave

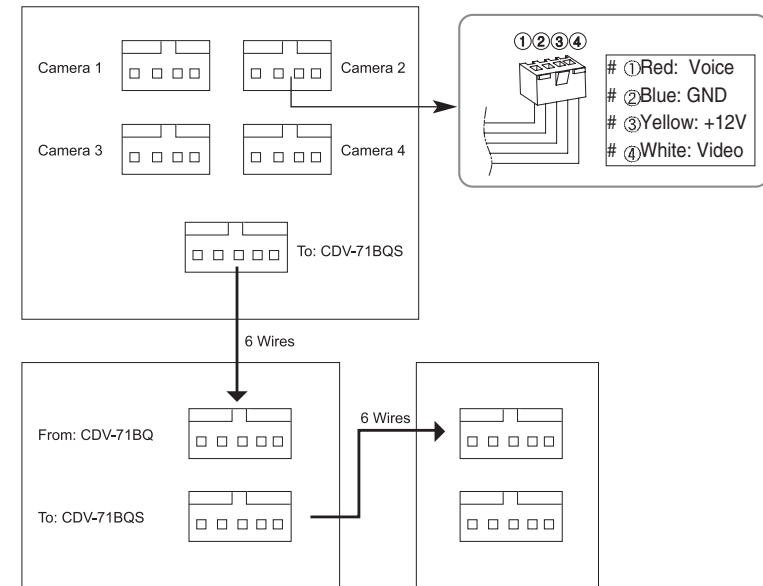

• Wiring diagram to CCTV Camera

- Please connect CCTV camera to one of the 4 channels
- CCTV CAMERA is needed separate power source.
- Please select the type of Coaxial Cable depending on installation distance from the Mater unit to the CCTV Camera.

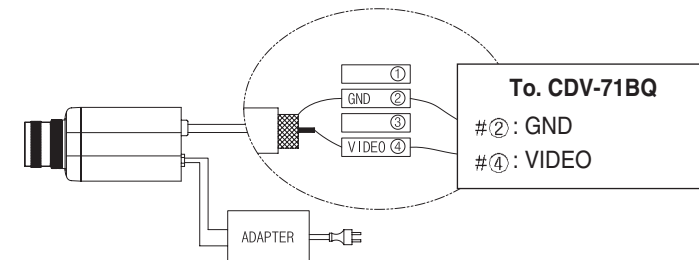

## 6. Installation method

### Installation method of monitor

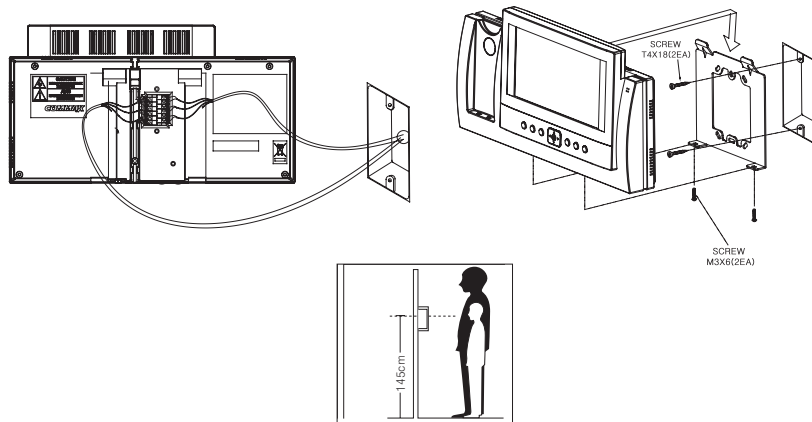

#### Notes for installing

- Please keep the product away from magnetism, severe moisture, direct sun rays and nearby heater, which may influence on the product
- Suitable height for main unit is 1450 ~ 1500mm from the bottom to the screen.
- Please arrange the handset after installation is completed
- Please refer to [7. Camera Setup] regarding the Installation of Camera units

### Installation method of camera (at DRC-4CH)

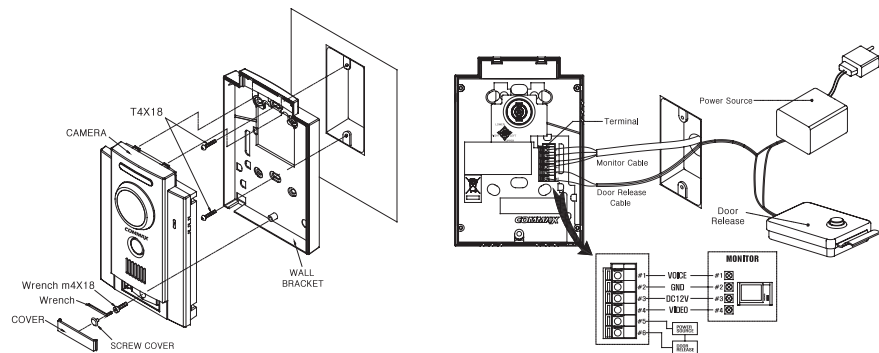

- Please keep the product away from direct sun rays or strong reflected light  
You may not get clear screen quality.

## 7. Operation Description

### 1. Visitor call & Monitoring

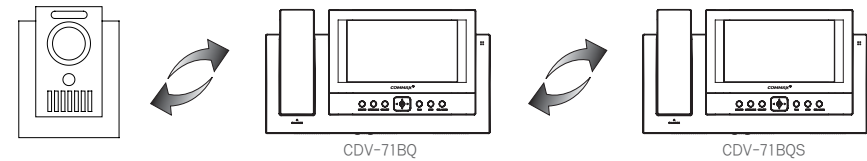

- ① When you push the [CALL] button on Camera unit, you can hear the chime sound from the Master(CDV-71BQ), Sub-Monitor(CDV-71BQS) and the visitors' picture as well as Camera Number will be shown on a screen with quad display .  
(Duration of on-screen : 30 sec)
- ② You can pick up the handset if you want to talk.  
the screen is off while you' re talking, you can push [MONITOR] button in order to speak again. (Duration of talking: 60 sec)
- ③ After checking visitors, you can push [OPEN] button to open the door, while you press the button, the relay connection of door camera will be sustained.
- ④ Press the [MONITOR] button to see condition of the door in standby , and then press the [RIGHT ▷] or LEFT (<) button to see the screen of next camera.
- ♠ In this case, if the camera is not connected in Setup mode, that channel is passed.
- ⑤ While talking with door camera or monitoring camera, the door will be open if you press [OPEN] button.
- ⑥ While talking or monitoring over the camera, you may store 1 cut with quad display by pressing the [REC/DEL.] button

## 2. Sub-Monitor(CDV-71BQS)

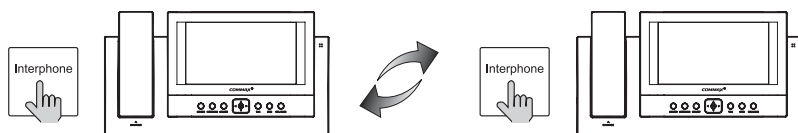

♣ This function is to call or to communicate the other room.

- ① When you pick up the handset and press the [INTERPHONE] button, you can hear the call sound from Sub units(CDV-71BQS) and then, you can start talking
- ② In order to open the door from Sub-monitor, you can press door open button

## 8. Menu Setting for CDV-71BQ

Press [Menu] button for the following display to change setup in standby

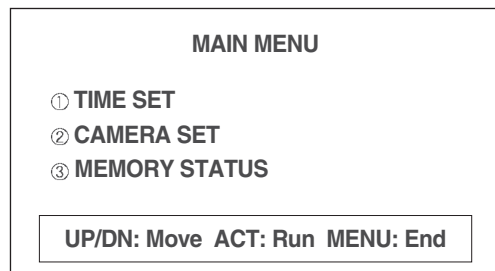

※ Note

- ① Set time
- ② Set Camera
- ③ Set recording status of visitors' pictures

### 1) Time setup

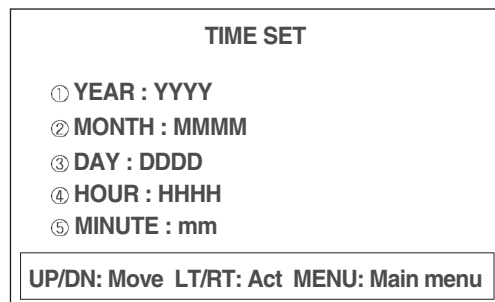

※ Note

- ① Set 'year'
- ② Set 'month'
- ③ Set 'date'
- ④ Set 'hour'
- ⑤ Set 'minute'

### 2) Camera Setup

- ① In this menu, you can activate which cameras you wish to display.
- ② It is connectable to a maximum of 4 cameras.
- ③ The default value is set to use all four cameras.

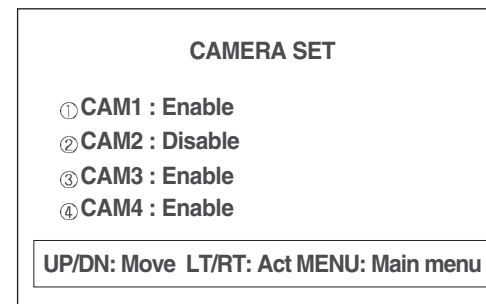

※ Note

- ① CAM1 : Activate
- ② CAM2 : Not activate
- ③ CAM3 : Activate
- ④ CAM4 : Activate

### 3) Memory Status

- ① This is to set the recording status

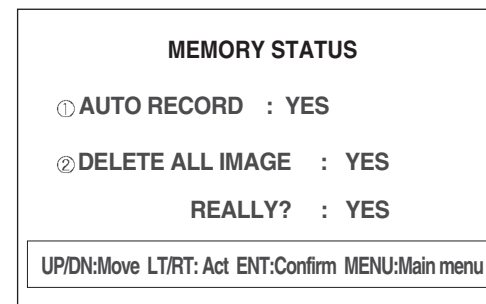

※ Note

- ① Setting "Auto Record" mode
- ② Delete all the recorded Image

♣ Please be careful when deleting

## 9. Picture Memory

### 1) Recording manually

① While you are monitoring outside of the house with CAV-71BQ or talking through door phone, you can press the [REC./DEL.] button to save 1 cut with quad display through the door camera or CCTV camera.

♣ This allows the visitors' picture to be recorded by either manual or auto mode.

### 2) Auto recording

- ① Automatically record a visitors' pictures on the memory of CDV-71BQ when you set the units on "away mode"
- ② This function runs in case of being set on "auto record" in "Memory status mode"
- ③ The Green Lamp on the top of CDV-71BQ will blink when it is Auto Recording.
  - Visitors' pictures are not stored when auto recording status lamp is off.
  - Max capacity of Memory : 1) NTSC :QUAD 68 Pictures.
  - 2) PAL :QUAD 58 Pictures.

### 3) Delete memorized pictures

- ① Delete 1 cut with quad display when you use the "review" mode,
- ② Please access the "Main menu" to delete all the memorized pictures. (Please refer to Fig H.)
  - Press [REC./DEL.] button and then using [LEFT/RIGHT] button move to the green box to "YES", then press [ENT] button.
- ③ Make sure that you are pressing the "YES" [ENT] button with green box

## 10. Review

- ① This is to see the stored screens.
- ② Stored screens are shown in quad display by pressing [REVIEW] button in standby



- ③ You can select quad images of visitors' picture recorded on screen using the and [LEFT <|]/[RIGHT >|] buttons,
- ④ Press [ENT] button scrolling through the image and selecting one to enlarge one of them. ( Press [ENT] button again to return to the quad display)
- ⑤ Press the [Review] again to quit this.

### Reviewing Images from the Server Monitor (CDV-71BQS)

In normal, standby mode, pressing the [REVIEW] button will display the screen as seen above in Fig 1.

- From this screen, pressing the [Pre] and [Next] buttons will allow the user to scroll through the 4 screens displayed.
- Pressing the [ENT] button will enlarge the highlighted cut to full-screen. In full-screen mode, pressing [Pre] and [Next] will allow the user to scroll back and forth through full-screen views of the 4 cameras. (Pressing [ENT] again will return the user back to Quad-screen view)



# 11. Screen Adjustment

## Screen Adjustment

- These functions allow the user to make desired screen adjustments.
- While monitoring the entrance, you can access the CONTROL MENU
- Using the [UPΔ]/[DOWN▽] buttons, scroll the  indicator to the desired setting you wish to change. Press the [ENT] button to make the level adjustment bar appear.
- Use the [UPΔ]/[DOWN▽] buttons to adjust to the desired level, and press the [ENT] button to return to the menu.



- Other display adjustments are made in the same manner as detailed above.
- If you wish to change the ratio of the screen, select 'Disp. Ratio' from the menu and press the [ENT] button. Push the [UPΔ]/[DOWN▽] buttons to change the ratio from (FULL & 4:3).

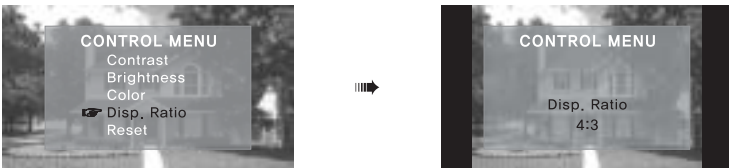

- If you want to change the initial value of the screen adjustment, push the [ENT] button after selecting 'Reset', and the value will return to its default setting.



- When all desired screen adjustments are made, push the MENU button to complete.

# 12. Trouble shooting

If you think that the product has trouble, please first check below contents before you ask a repair.

Troubles	Check Point	Actions
<ul style="list-style-type: none"> <li>• The power supply is not on.</li> <li>• All works are stopped</li> </ul>	<ol style="list-style-type: none"> <li>1.The power supply code is missing or not.</li> <li>2.The power supply switch (down) is off or not.</li> </ol>	<ol style="list-style-type: none"> <li>1. Please connect the power supply cord</li> <li>2. Please turn on the power supply switch (down) pushing to the right.</li> </ol>
<ul style="list-style-type: none"> <li>• A Call operation is not performed. (Door, Interphone function)</li> </ul>	<ol style="list-style-type: none"> <li>1.The wiring between other units is connected correctly in good order or not.</li> <li>2. The wiring is missing or not.</li> <li>3. A Room id is set or not.</li> </ol>	<ol style="list-style-type: none"> <li>1. Please refer to connection related page and manage.</li> <li>2. Please connect correctly to the terminal.</li> <li>3. Please refer to Room id setting related page.</li> </ol>
<ul style="list-style-type: none"> <li>• The product does not produce the sound. (Call volume, Talk volume)</li> </ul>	<ol style="list-style-type: none"> <li>1. A sound volume lies in minimum or not.</li> </ol>	<ol style="list-style-type: none"> <li>1. Please adjust the sound volume properly turning to the right, as you want.</li> </ol>
<ul style="list-style-type: none"> <li>• The screen is dark.</li> <li>• The screen is strange.</li> </ul>	<ol style="list-style-type: none"> <li>1. There is a strong reflected light behind the visitor or not.</li> <li>2. The screen control is adjusted correctly.</li> </ol>	<ol style="list-style-type: none"> <li>1. Please change the angle of camera lens.</li> <li>2. Please initialize the screen control. (Refer to setting related page)</li> </ol>
<ul style="list-style-type: none"> <li>• We can see the visitor image but no voice.</li> </ul>	<ol style="list-style-type: none"> <li>1. The connector on the handset is properly inserted to the product?</li> </ol>	<ol style="list-style-type: none"> <li>1.Please put the connector properly again.</li> </ol>
<ul style="list-style-type: none"> <li>• No stored image found</li> </ul>	<ol style="list-style-type: none"> <li>1. Auto recording is assigned?</li> </ol>	<ol style="list-style-type: none"> <li>1.Please set the status of "AUTO RECORD" as "YES"</li> </ol>

## 13. Specification

ITEM	CONTENTS (CDV-71BQ)
Wiring	Camera : 4 lines in polarity, Sub-Monitor : 6 lines in polarity
Rated voltage	AC100-240V~, 50/60Hz
Power consumption (On operating)	CDV-71BQ : 25W (Max.)
Display unit	7" TFT-LCD
Call sound	Door(individual door): ring electronic chime 3 sounds twice repeatedly, Interphone : Electronic melody sound
Time for screen working	30sec (On call : for 60sec)
Image memory	NTSC : 68 Cuts(Quad)
	PAL : 58 Cuts(Quad)
Communication distance	To Door camera: 30M(at $\varnothing$ 0.5mm)/ 50M(at $\varnothing$ 0.65mm)/ 70M(at $\varnothing$ 0.8mm) / 115M(at $\varnothing$ 1.0mm)
	To Sub-Monitor: 30M(at $\varnothing$ 0.65mm)/ 50M(at $\varnothing$ 0.8mm)
Operating temperature	0°C~ 40°C
Dimension	315(W)x175(H)x53(D)
Weight	1.7kg

ITEM	CONTENTS (CDV-71BQS)
Wiring	Input & out put : 6 lines in polarity,
Rated voltage	AC100-240V~, 50/60Hz
Power consumption (On operating)	CDV-71BQS : 18W (MAX.)
Display unit	7" TFT-LCD
Call sound	Door(individual door): ring electronic chime 3 sounds twice repeatedly, Interphone : Electronic melody sound
Time for screen working	30sec (On call : for 60sec)
Communication distance	To Sub-Monitor: 30M(at $\varnothing$ 0.65mm) / 50M(at $\varnothing$ 0.8mm)
Operating temperature	0°C~ 40°C
Dimension	315(W)x175(H)x53(D)
Weight	1.7kg

# **COMMAX**

**Blooming Life, HomeNetwork**

## **COMMAX Co.,Ltd.**

a513-11, Sangdaewon-dong, Jungwon-gu, Seongnam-si, Gyeonggi-do, Korea  
Int'l Business Dept. : Tel.; +82-31-7393-540~550 Fax.; +82-31-745-2133  
Web site : [www.commax.com](http://www.commax.com)

*Printed In Korea/2007.04*