

Since 1968

COMMAX
SmartHome & Security

User Manual

FLOOR DISTRIBUTOR CCU-FS



www.commax.com

COMMAX Co.,Ltd.



- Thank you for purchasing COMMAX products.
- Please carefully read this User's Guide (in particular, precautions for safety) before using a product and follow instructions to use a product exactly.
- The company is not responsible for any safety accidents caused by abnormal operation of the product.



Table of Contents

Warnings and caution	2
Application	4
Specifications	4
Floor Distributor Power	5
Using a Separate Power Supply	5
System power diagram	6
System Diagram and wiring	8
CCU-FS Wiring method and the role of each connector	9
UTP CABLE wiring	10
UTP CABLE Configuration between a Multi-Entry Panel and a Building Distributor	10
CABLE Configuration between a Building Distributor and a Floor Distributor	11
UTP Configuration between a Floor Distributor and House Units	11



Warnings and caution

◎ Make sure to follow the instructions to prevent any danger or property losses.



Warning Death or serious injury is expected.



It indicates prohibition.



It indicates prohibition of disassembly.



It indicates prohibition of contact.



It indicates dos and don'ts.



It indicates that the plug should be pulled out from the socket.



Warning

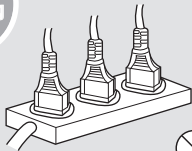

Prohibition

Do not put the plug in the socket simultaneously.

It may generate abnormal heat or cause a fire.

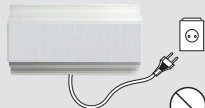

Prohibition

Do not connect to other products while in use.

It may cause breakdown.

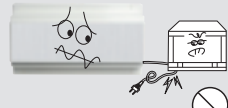

Prohibition

Do not forcibly bend the cord or put a heavy object on the product.

It may cause a fire.



Prohibition

Do not use water, thinner or a detergent used to wash oil products when you wash the exterior.

Make sure to wash it by using a dry cloth to prevent any breakdown or electric shock.



Prohibition

Do not install the product in a humid place.

It may cause an electric shock or a fire.

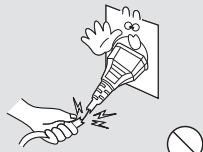

Prohibition

Do not forcibly pull out the cord from the socket.

If the cord is damaged, it may cause a fire or an electric shock.

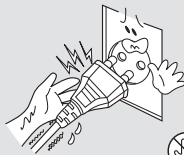

Do not contact.

Do not put the plug in the socket with a wet hand.

It may cause an electric shock.



Do not disassemble

Do not disassemble, repair or modify the product.

It may cause a fire, an electric shock or an injury due to malfunction of the product.

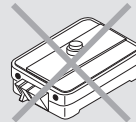

Do not use AC circuit breaker.

It may cause an electric shock.

Warnings and caution



Caution An injury or property losses are expected

- It indicates prohibition.
- It indicates prohibition of disassembly.
- It indicates prohibition of contact.
- It indicates dos and don'ts.
- It indicates that the plug should be pulled out from the socket.



Caution

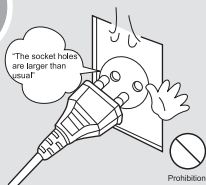

If the socket holes are larger than normal, do not put the plug.

It may cause an electric shock or a fire.

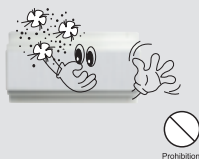

Make sure that dust or foreign substances are not gathered on the product.

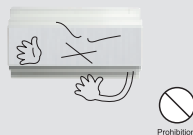

Make sure to prevent foreign substances from entering the product.

It may cause a breakdown.

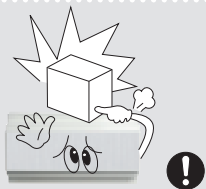

Do not put a heavy object on the product.

It may cause a breakdown.

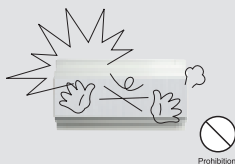

Do not disassemble or give an impact to the product.

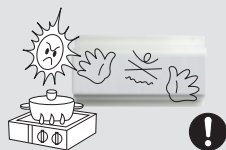

Avoid direct rays of the sun or heating devices at a time of installation.



Install the product in a flat and stable place.

Otherwise, it may not function properly.

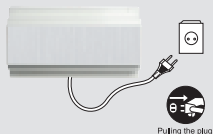

Pull the plug if the product is not used for a long time.

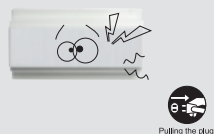

If the product generates strange sound, make sure to pull the plug immediately and contact Commax service center.

1. Application

This is an 8-wires Floor distributor which is a DIN RAIL type compact in size. It is a connector between the Building Distributor(CCU-BS) and In-house units. It needs a power source of DC 28V to supply the power and signals to In-house units.



2. Specifications

Item \ Model	CCU-FS
Wiring	To Building distributor : 8-wire (talk2, Data1, VCC, Video, GND) To In-house Unit : 6-wire(talk 2, Data1, VCC, Video, GND)
Power voltage	28V/5A
PowerCCU-FS Requirements	CCU-FS With 1 residence unit Standby : 200m Maximum operation: 510mA
Installation range and wiring type	Installation Range : Per floor 4 meters / Maximum 50 floors; from Building distributor to last floor distributor (50 floors) : less than 200 meters
wiring type	ALL UTP (CAT.5) cable
28V/5A	Supports 8 floors, 32 room units (with one videophone per Household)

♣ Floor Distributor Power

When using DC28V/ 5A power, one power supply can cover up to 8 floor distributors (32 housing units) when connecting 1 in-house-unit per residence.

The diagram below displays the maximum capability for one power supply coverage.

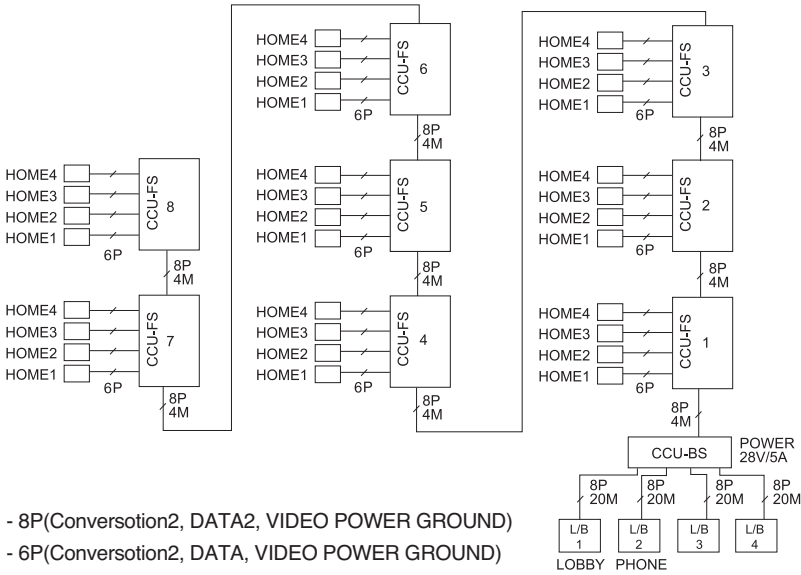

- ① The first power supply should be powered with the 3rd floor distributor unit (28V/5A).
- ② The distance between each floor distributor is suggested to be within 4 meters as the maximum range between the building distributor to the 8th distributor should not exceed 32 meters.
- ③ The floor distributor is connect to the household unit through 6 wires, which should not exceed 50 meters.

♣ Using a Separate Power Supply

- ① One floor distributor can cover up to 4 housing units.
 (The addition of a slave unit requires a separate power supply)
- ② The entry panel extension unit(DR-nMS) for entry panel main unit (DRC-6SB, DR-8SB) requires an additional power supply.
 The maximum distance between the entry panel units and the building distributor (CCU-BS) is 20 meters. If more distance is needed, a separate power supply is required and can extend the range more than 100 meters.

🌿 System power diagram (When one power supply cover up to 8 floor distributors)

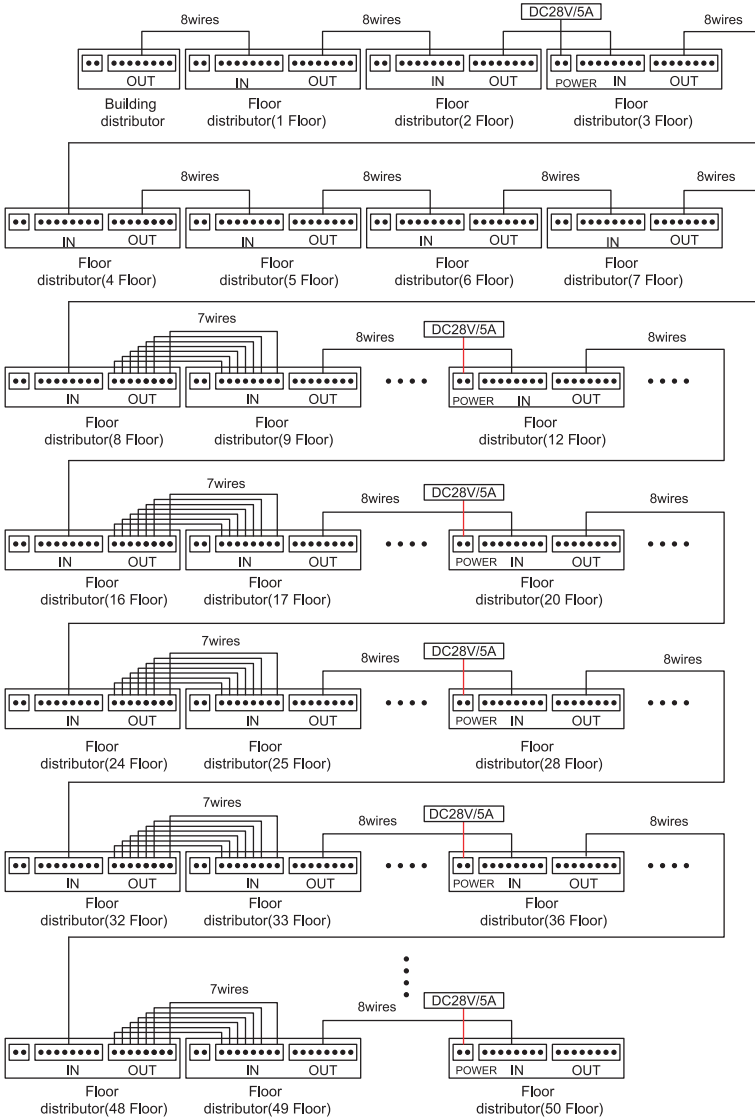

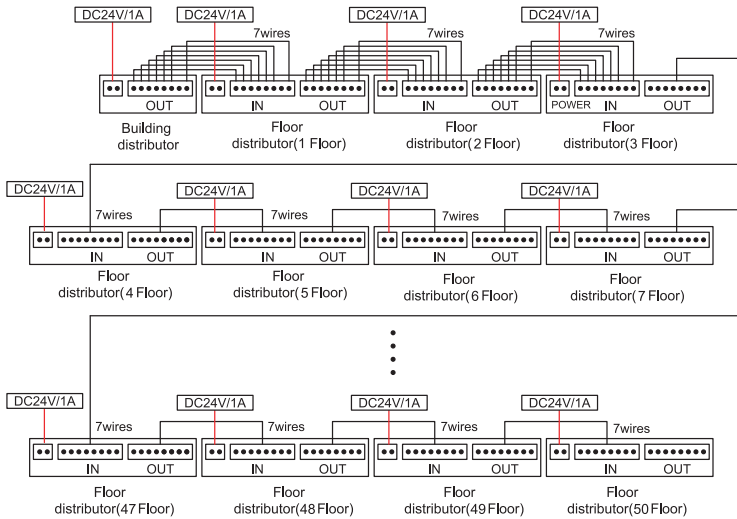

- The picture above shows the maximum power one building distributor can cover. This supports for stable power distribution to run.

① it is highly recommended to install the power supply to the 3rd floor distributor to provide ample power between the floor 1 through floor 8 distributors.
Power source: (DC28V/5A)

② The following wiring is recommended for stable power supply and to prevent possible interference.

- Disconnect from the 8th floor distributor OUT-terminal to 7th wire (+28V VCC) in the 9th floor distributor IN-terminal, because the 3rd floor distributor power supply (28V/5A) will be transmitted to each floor distributors from floors 9 through 16.
- Disconnect from the 16th floor distributor OUT-terminal to 7th wire(+28V VCC) in the 17th floor distributor IN-terminal, because the 12rd floor distributor power supply (28V/5A) will be transmitted to each floor distributors from floors 17 through 23.
- Disconnect from the 24th floor distributor OUT-terminal to 7th wire(+28V VCC) in the 25th floor distributor IN-terminal, because the 20rd floor distributor power supply (28V/5A) will be transmitted to each floor

- Disconnect from the 32th floor distributor OUT-terminal to 7th wire(+28V VCC) in the 33th floor distributor IN-terminal, because the 28rd floor distributor power supply (28V/5A) will be transmitted to each floor distributors from floors 24 through 31
- Disconnect from the 40th floor distributor OUT-terminal to 7th wire(+28V VCC) in the 41th floor distributor IN-terminal, because the 36rd floor distributor power supply (28V/5A) will be transmitted to each floor distributors from floors 32 through 40.
- Disconnect from the 48th floor distributor OUT-terminal to 7th wire(+28V VCC) in the 49th floor distributor IN-terminal, because the 44rd floor distributor power supply (28V/5A) will be transmitted to each floor distributors from floors 41 through 48.
- The final 50th floor distributor power supply(28v/5A) cover 49th and 50th floor distributor.

3. System Diagram and wiring

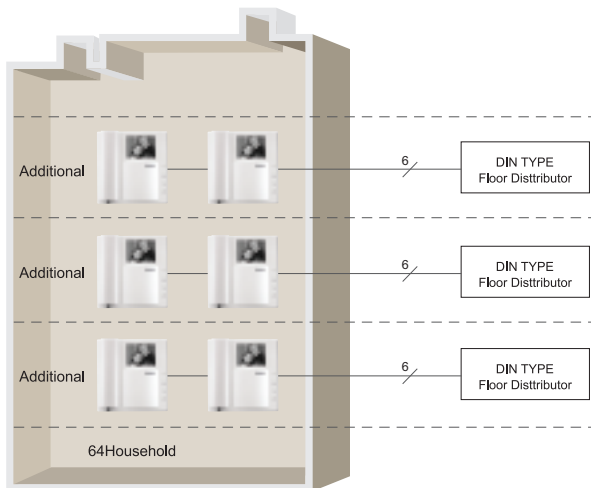

- Wiring the Building distributor(CCU-BS) to Floor distributor (8 wires : talk 2, Data 2, Video, GND)
- Connecting the Floor distributor with the next Floor distributor (8 wires : talk 2, Data 2, Video, GND)
- Each Floor distributor is connectable to up to 4 residences.
- Additional Sub-units in each residence are available (Maximum of 3 units including a Master unit)
- Separate power source is needed for additional Sub-units (Not required for Audio type sub-units)

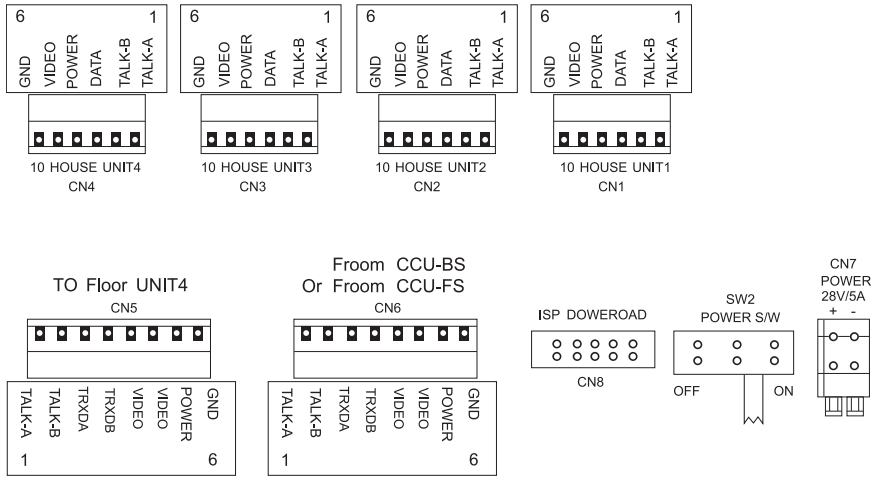

♠ CCU-FS Wiring method and the role of each connector

- CN1 : Connect to 1st in-house unit with 6 wires (talk 2, Data 1, Power 1, Video 1, GND 1)
- CN2 : Connect to 2nd in-house unit with 6 wires (talk 2, Data 1, Power 1, Video 1, GND 1)
- CN3 : Connect to 3rd in-house unit with 6 wires (talk 2, Data 1, Power 1, Video 1, GND 1)
- CN4 : Connect to 4th in-house unit with 6 wires (talk 2, Data 1, Power 1, Video 1, GND 1)
- CN5 : Connect to next Floor Distributor unit with 8 wires (talk 2 ,Data 2, Video2, Power 1,GND 1)
- CN6 : Connect to Building Distributor (CCU-BS) or previous Floor distributor with 8 wires (talk 2 , Data 2, Video2, Power 1, GND 1)
- CN7 : Connect to DC Power of 28V/5A
- CN8 : Connect to Personal computer to download the program for ISP
- SW2 : Power on-off for Building Distributor.

4. UTP CABLE wiring

In this system, the multi-entry panel units use one UTP cable to transmit the DATA, TALK, VIDEO, POWER to all household units .

The diagram below details the most effective wiring method to transmit DATA, TALK, VIDEO, POWER between all system units.

If the wiring sequences below are not carefully followed, the clearest audio and video quality cannot be guaranteed.

♣ UTP CABLE Configuration between a Multi-Entry Panel and a Building Distributor.

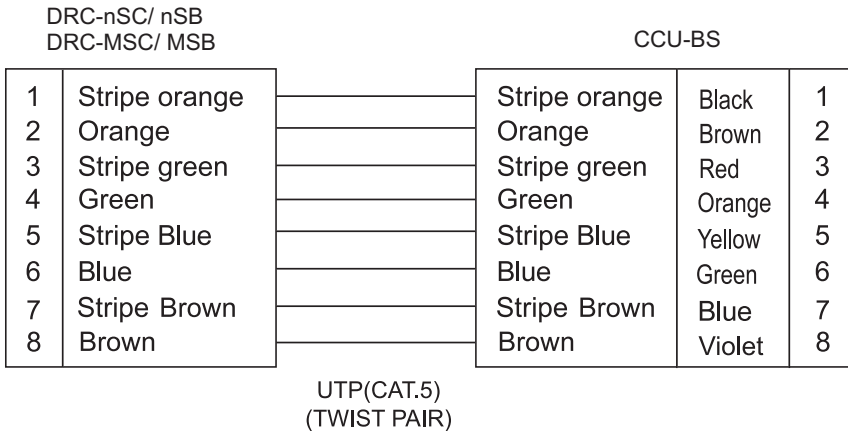

1, 2 wires – TALK/ 3,4 wires - DATA/ 5,6 wires – VIDEO/ 7,8 wires – POWER & GND

♠ CABLE Configuration between a Building Distributor and a Floor Distributor

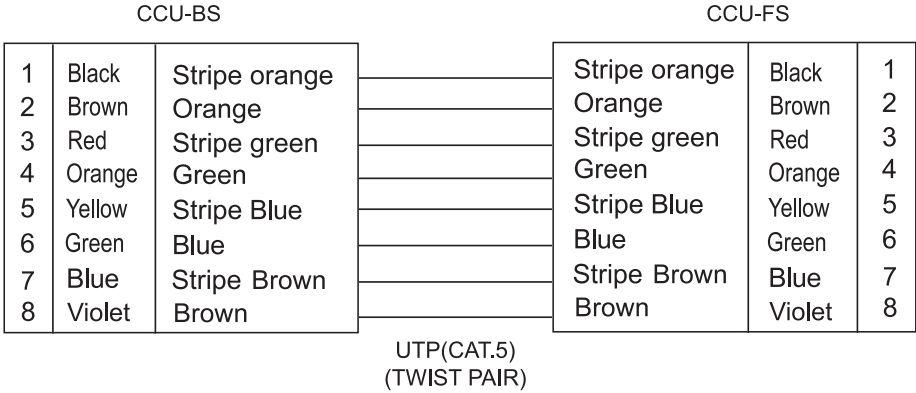

1,2 wires – TALK/ 3,4 wires – DATA/ 5,6 wires – VIDEO/ 7,8 wires – POWER & GND

♠ UTP Configuration between a Floor Distributor and House Units

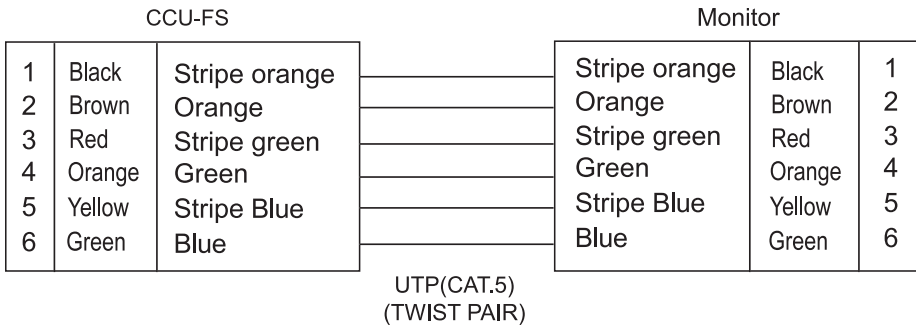

1,2 wires – TALK/ 3 wire – DATA/ 4 wire – POWER (VCC)/ 5 wire – VIDEO/ 6 wire - GND



Memo

COMMAX

COMMAX Co.,Ltd.

513-11, Sangdaewon-dong, Jungwon-gu, Seongnam-si, Gyeonggi-do, Korea

Int'l Business Dept. Tel. : +82-31-7393-540~550 Fax. : +82-31-745-2133

Web site : www.commax.com

PM32FS000010

Printed In Korea / 2011.03.104